



COLLEZIONE 2016



IDEATO E CREATO IN **ITALIA**

DESIGNED AND MANUFACTURED IN **ITALY**



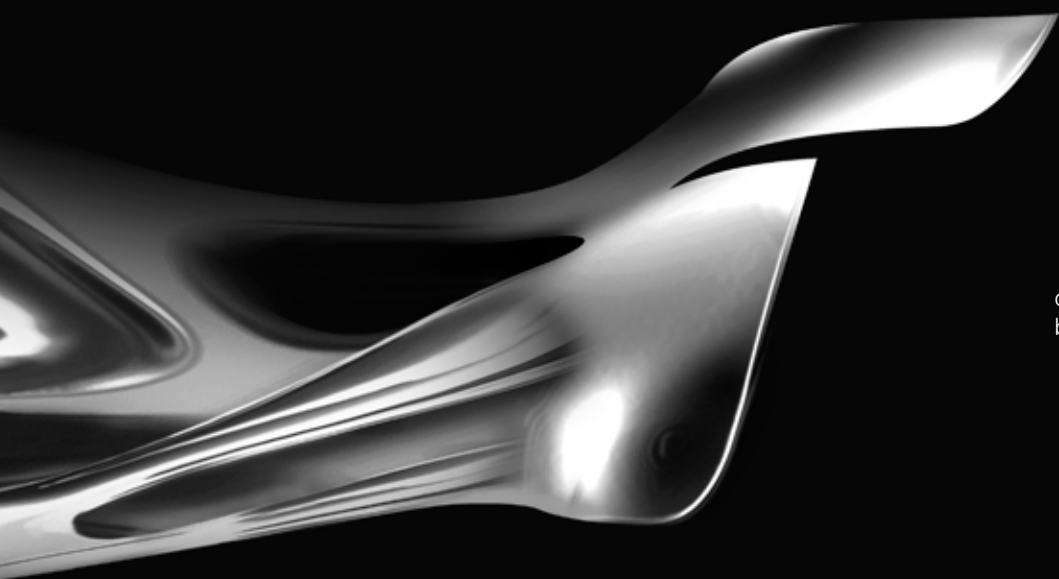

creativity recognizes no rules,
but structures the future.





UNIVERSAL

8	MIRRORS
48	MIRROR ADAPTORS
58	MARKER LIGHTS
66	PROGUARD SYSTEM®
70	BRAKE / CLUTCH LEVERS
80	GRIPS
92	HANDLEBAR CAPS
94	HANDLEBARS
96	CROSSBAR
98	RISER
100	FLUID TANKS
106	FLUID TANK CAPS
110	ENGINE OIL FILLER CAPS
112	GAS TANK CAPS
116	ENGINE / FAIRING GUARDS
122	WHEEL AXLE PROTECTIONS
126	REAR SET CONTROL KITS
130	PEGS FOR OEM CONTROLS
134	PEGS "STREET" / "TOURING"
138	HEADLIGHT FAIRING
140	FRONT FENDERS
142	REAR FENDERS
144	LICENSE PLATE SUPPORTS
150	SWING ARM SPOOLS
151	CLEANING KIT

BIKE ACCESSORY LINES

BMW®	152	R nineT
	158	S 1000 R
	162	R 1200 R
	164	S 1000 RR
	168	S 1000 XR
	172	R 1200 GS
DUCATI®	180	SCRAMBLER
	188	MONSTER 1200
	192	MONSTER 821
	194	MONSTER
	198	DIAVEL
	202	HYPERMOTARD/HYPERSTRADA
	206	MULTISTRADA
	210	1199 / 899 PANIGALE
	214	MONSTER OLD SERIES
HONDA®	218	CB 1000 R
	222	CB 650 F
	224	CBR 1000 RR
	226	CBR 600 RR
KAWASAKI®	228	Z 1000
	232	Z 800
	234	Z 300
	238	NINJA 1000 ZX-10R
	240	NINJA 600 ZX-6R
	242	NINJA 300 ZX-6R
MV AGUSTA®	244	RIVALE
	248	BRUTALE / DRAGSTER 800
	252	F3 675
SUZUKI®	254	GSR 750 / GSX-S750
	256	GSX R 1000 / 750 / 600
TRIUMPH®	258	BONNEVILLE T100
	260	SPEED TRIPLE
	262	STREET TRIPLE
YAMAHA®	266	XJR 1300
	268	XV950R
	270	MT-09 TRACER / FJ-09
	272	MT-09 / FZ-09
	276	MT-07 / FZ-07
	278	YZF R1
	282	YZF R6
	284	T-MAX

VELOCE



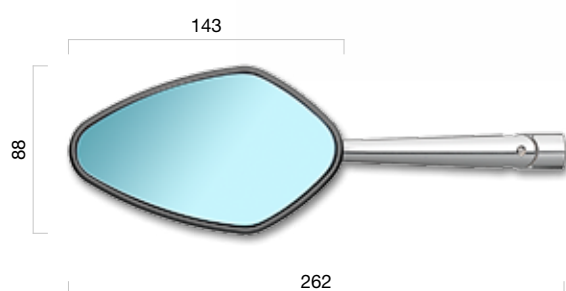

E-HOMOLOGATION | CONVEX AND ANTIGLARE GLASS
 STRUCTURAL ELEMENT IN ALUMINUM MACHINED FROM BILLET
 AERODYNAMIC POLYMER SHELL | 3D MACHINING

SPORT NAKED CRUISER TOURING SCOOTER

VELOCE SPORT

Position	<input type="checkbox"/>	<input checked="" type="checkbox"/>
Biposition	BS205A	BS205B

VELOCE NAKED

Position	<input type="checkbox"/>	<input checked="" type="checkbox"/>
Biposition	BS206A	BS206B

Adaptors pages 48 - 57



VELOCE L



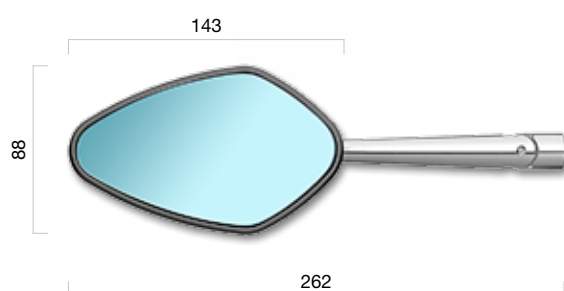

E-HOMOLOGATION | INTEGRATED MARKER LIGHT | CONVEX AND ANTIGLARE GLASS
 STRUCTURAL ELEMENT IN ALUMINUM MACHINED FROM BILLET
 AERODYNAMIC POLYMER SHELL | 3D MACHINING

SPORT	NAKED	CRUISER	TOURING	SCOOTER
-------	-------	---------	---------	---------

VELOCE L SPORT

Position	<input type="checkbox"/>	<input checked="" type="checkbox"/>
Biposition	BS305A	BS305B

VELOCE L NAKED

Position	<input type="checkbox"/>	<input checked="" type="checkbox"/>
Biposition	BS306A	BS306B

Adaptors pages 48 - 57

Marker light cable kit page 65



DRIFT



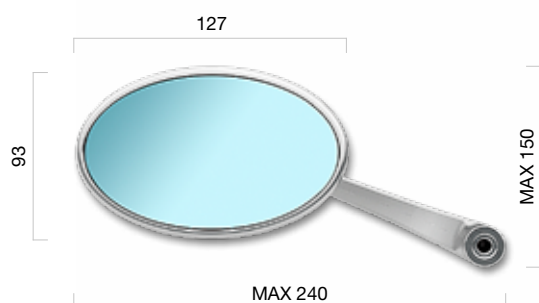

E-HOMOLOGATION | CONVEX AND ANTIGLARE GLASS
MACHINED FROM BILLET ALUMINUM | 3D MACHINING

SPORT	NAKED	CRUISER	TOURING	SCOOTER
-------	-------	---------	---------	---------

DRIFT

Position	<input type="checkbox"/>	<input checked="" type="checkbox"/>
Biposition	BS400A	BS400B



Adaptors pages 48 - 57

ONE



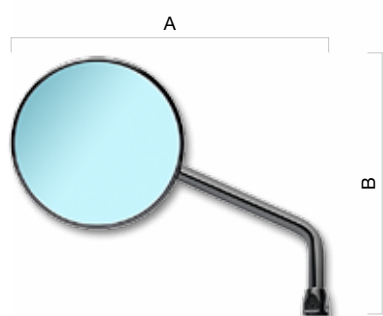

Art.	A (mm)	B (mm)
BS250B	186	167
BS251B	179	197



E-HOMOLOGATION | CONVEX AND ANTIGLARE GLASS
MACHINED FROM BILLET ALUMINUM | 3D MACHINING | CLASSIC SOUL

SPORT	NAKED	CRUISER	TOURING	SCOOTER
-------	-------	---------	---------	---------

ONE

Brand	Model	Year	Position	■
All	All	All	Biposition	BS250B
Harley-Davidson®	All	All	Biposition	BS251B



Adaptors pages 48 - 57 (for Harley-Davidson® adaptors are included)

4D



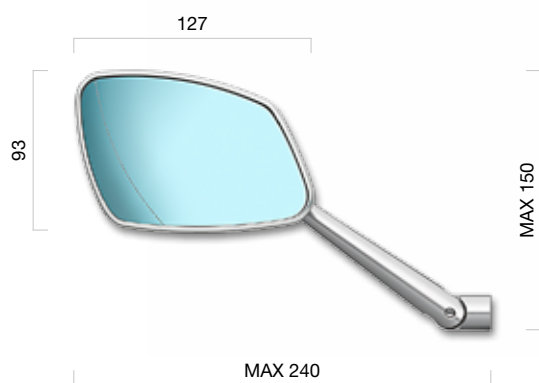

E-HOMOLOGATION | CONVEX, ANTIGLARE AND ASPHERIC GLASS
 MACHINED FROM BILLET ALUMINUM | 3D MACHINING
 AERODYNAMICALLY DESIGNED

4D

Position	■	■
Left	BS208A	BS208B
Right	BS207A	BS207B

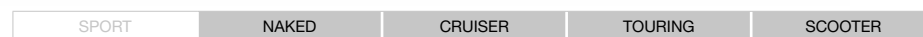

Adaptors pages 48 - 57

RADIAL

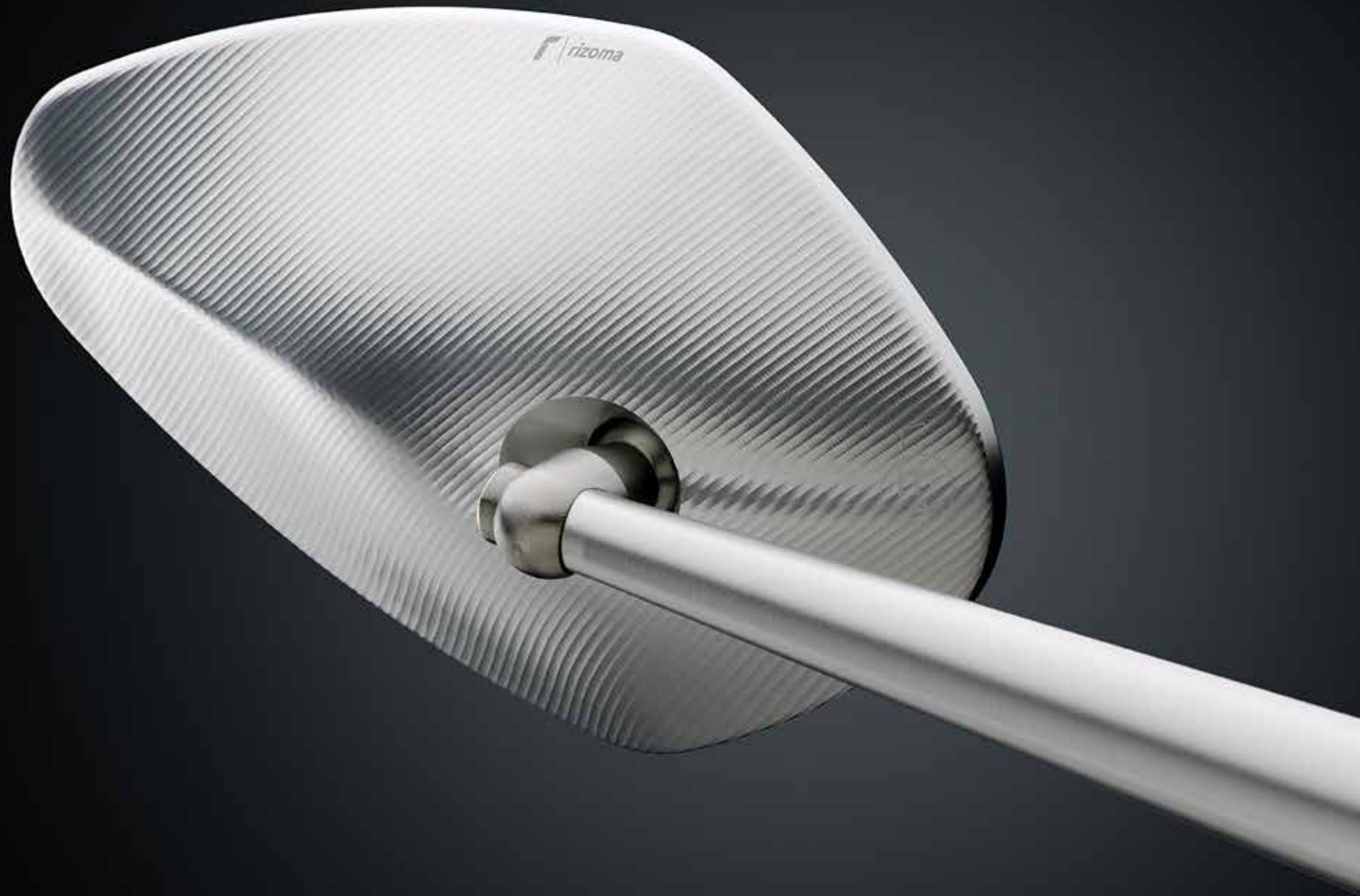

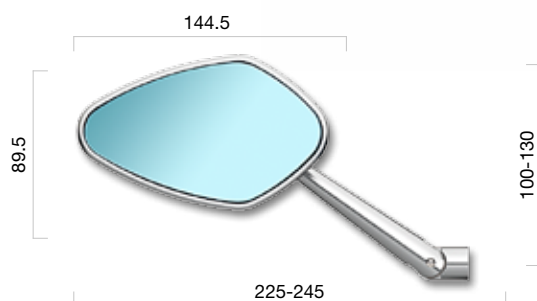

E-HOMOLOGATION | CONVEX AND ANTIGLARE GLASS
MACHINED FROM BILLET ALUMINUM | 3D MACHINING

SPORT NAKED CRUISER TOURING SCOOTER

RADIAL

Position	<input type="checkbox"/>	<input checked="" type="checkbox"/>	<input type="checkbox"/>
Biposition	BS130A	BS130B	BS130BG



Adaptors pages 48 - 57

ELISSE



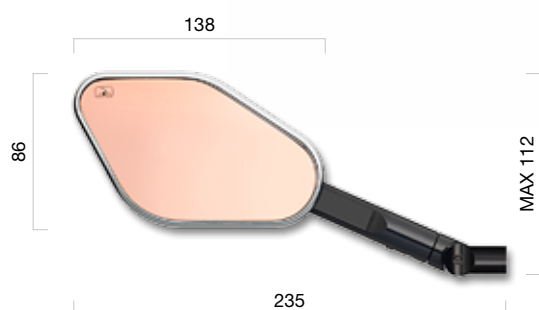

E-HOMOLOGATION | WATERPROOF, CONVEX AND ANTIGLARE AMBER GLASS
MACHINED FROM BILLET ALUMINUM | 3D MACHINING

SPORT

NAKED

CRUISER

TOURING

SCOOTER

ELISSE

Position	■	■
Sinistro	BS171AB	BS171B
Destro	BS172AB	BS172B



Adaptors pages 48 - 57

LIMIT



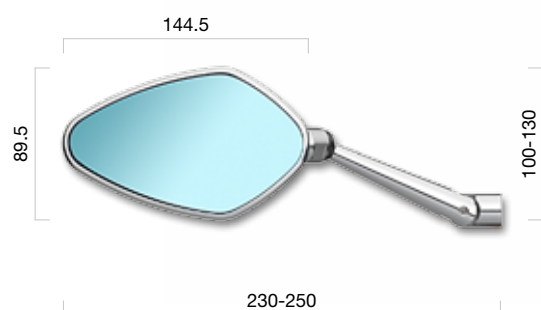

E-HOMOLOGATION | CONVEX AND ANTIGLARE GLASS
MACHINED FROM BILLET ALUMINUM
3D MACHINING | HIGH LEVEL AERODYNAMICS

SPORT

NAKED

CRUISER

TOURING

SCOOTER

LIMIT SPORT

Position	<input type="checkbox"/>	<input checked="" type="checkbox"/>
Biposition	BS150A	BS150B

LIMIT NAKED

Position	<input type="checkbox"/>	<input checked="" type="checkbox"/>
Biposition	BS154A	BS154B

Adaptors pages 48 - 57



CIRCUIT 851





ANTI GLARE GLASS | MACHINED FROM BILLET ALUMINUM | 3D MACHINING
SMALL DIMENSIONS | AVAILABLE IN THREE FINISHES

- SPORT
- NAKED
- CRUISER
- TOURING
- SCOOTER

CIRCUIT 851

Position	■	■	■
Left	BS010A	BS010B	BS010L
Right	BS011A	BS011B	BS011L



Adaptors pages 48 - 57

CIRCUIT 959



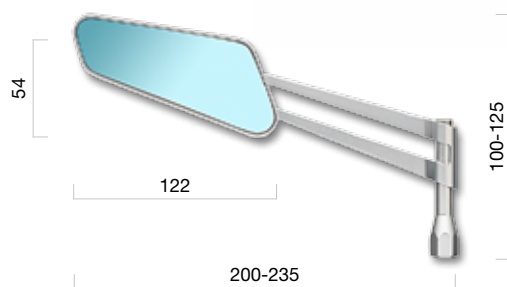

ANTI GLARE GLASS | MACHINED FROM BILLET ALUMINUM | 3D MACHINING
SMALL DIMENSIONS | AVAILABLE IN THREE FINISHES

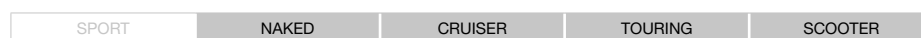

CIRCUIT 959

Position	■	■	■
Left	BS204A	BS204B	BS204L
Right	BS203A	BS203B	BS203L



Adaptors pages 48 - 57

CIRCUIT 744



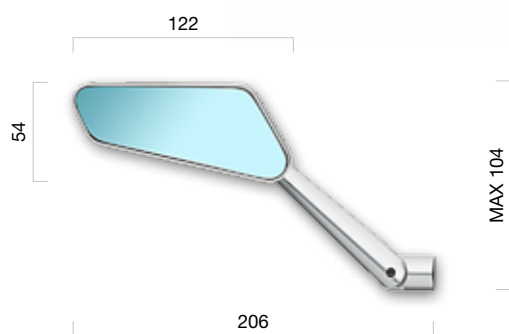

ANTI GLARE GLASS | MACHINED FROM BILLET ALUMINUM
3D MACHINING | SMALL DIMENSIONS

SPORT

NAKED

CRUISER

TOURING

SCOOTER

CIRCUIT 744

Position	■	■
Left	BS202A	BS202B
Right	BS201A	BS201B



Adaptors pages 48 - 57

LINEA



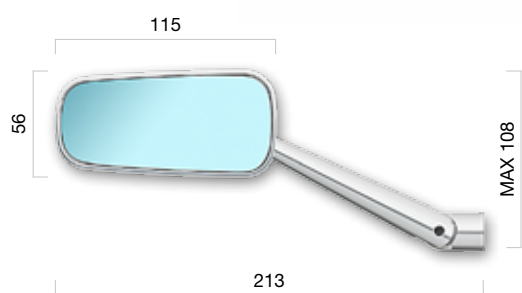

ANTI GLARE GLASS | MACHINED FROM BILLET ALUMINUM
3D MACHINING | SMALL DIMENSIONS

SPORT	NAKED	CRUISER	TOURING	SCOOTER
-------	-------	---------	---------	---------

LINEA

Position	<input type="checkbox"/>	<input checked="" type="checkbox"/>
Biposition	BS196A	BS196B



Adaptors pages 48 - 57

TOMOK



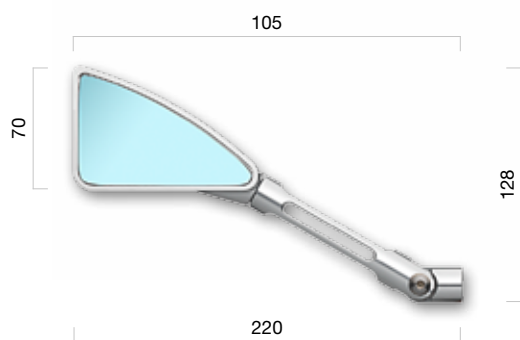

ANTI GLARE GLASS | MACHINED FROM BILLET ALUMINUM
3D MACHINING | SMALL DIMENSIONS | ICONIC STYLE

SPORT

NAKED

CRUISER

TOURING

SCOOTER

TOMOK

Position	■	■	■
Left	BS160A	BS160B	BS160BG
Right	BS162A	BS162B	BS162BG



Adaptors pages 48 - 57

DYNAMIC



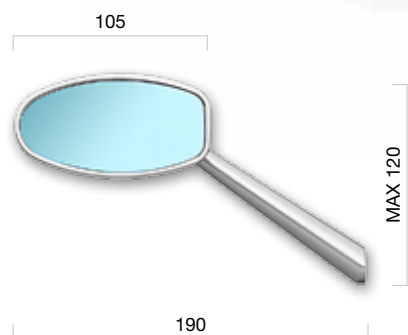

CONVEX AND ANTIGLARE GLASS | MACHINED FROM BILLET ALUMINUM
3D MACHINING | SMALL DIMENSIONS

SPORT	NAKED	CRUISER	TOURING	SCOOTER
-------	-------	---------	---------	---------

DYNAMIC

Position	<input type="checkbox"/>	<input checked="" type="checkbox"/>	<input type="checkbox"/>
Biposition	BS080A	BS080B	BS080L



Adaptors pages 48 - 57

REVERSE RETRO



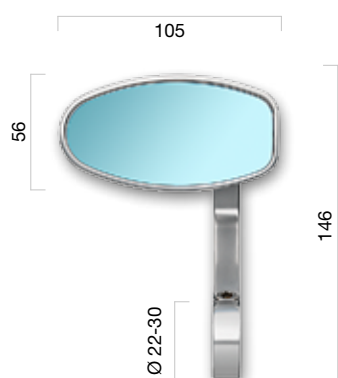

CONVEX AND ANTIGLARE GLASS | MACHINED FROM BILLET ALUMINUM
3D MACHINING | SMALL DIMENSIONS

REVERSE RETRO

Position	<input type="checkbox"/>	<input checked="" type="checkbox"/>	<input type="checkbox"/>
Biposition	BS070A	BS070B	BS070L

SPORT NAKED CRUISER TOURING SCOOTER



Adaptors pages 48 - 57

SPY-ARM





MA303A / MA303B
Handlebar Cap
for SPY-ARM



CONVEX AND ANTIGLARE GLASS | MACHINED FROM BILLET ALUMINUM
3D MACHINING | USABLE WITH Ø 22 mm (7/8) AND 25,4 mm (1 INCH) HANDLEBAR
TWO DIMENSIONS AVAILABLE

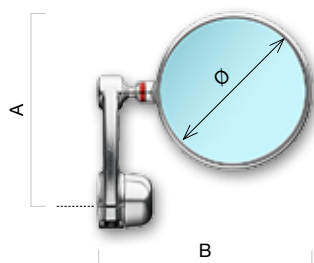

Art.	Ø (mm)	A	B
BS303	80	103	116.5
BS300	94.5	110	130.5

SPORT	NAKED	CRUISER	TOURING	SCOOTER

SPY-ARM

Ø (mm)	Homologation	Position	■	■
80	—	Biposition	BS303A	BS303B
94.5	✓	Biposition	BS300A	BS300B



SPY-R





MA301B
Handlebar Cap
for SPY-R



CONVEX AND ANTIGLARE GLASS | MACHINED FROM BILLET ALUMINUM
3D MACHINING | THREE DIMENSIONS AND TWO COLORS AVAILABLE

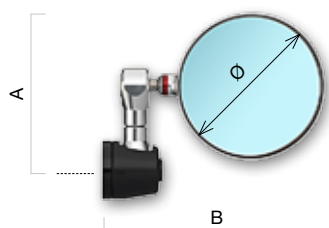

Art.	Ø (mm)	A	B
BS185	57	75	101
BS285	80	88	127
BS294	94.5	95	141

SPORT	NAKED	CRUISER	TOURING	SCOOTER
-------	-------	---------	---------	---------

SPY-R

Ø (mm)	Homologation	Position	■	■
57	—	Biposition	BS185A	BS185B
80	—	Biposition	BS285A	BS285B
94.5	✓	Biposition	BS294A	BS294B



SPY-Q





MA301B
Handlebar Cap
for SPY-Q



ANTI GLARE GLASS | MACHINED FROM BILLET ALUMINUM
3D MACHINING | SMALL DIMENSIONS

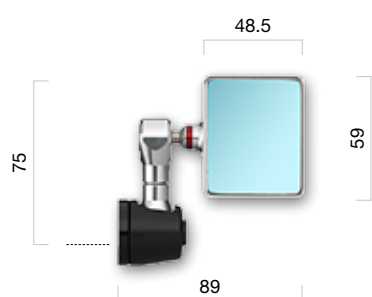

SPY-Q

Position	<input type="checkbox"/>	<input checked="" type="checkbox"/>
Biposition	BS186A	BS186B

SPORT	NAKED	CRUISER	TOURING	SCOOTER
-------	-------	---------	---------	---------



SPIRIT





MA301B
Handlebar Cap
for SPIRIT



E-HOMOLOGATION | CONVEX AND ANTIGLARE GLASS
STRUCTURAL ELEMENT IN ALUMINUM MACHINED FROM BILLET
AERODYNAMIC POLYMER SHELL | 3D MACHINING | MODERN LINES FOR A CLASSIC STYLE

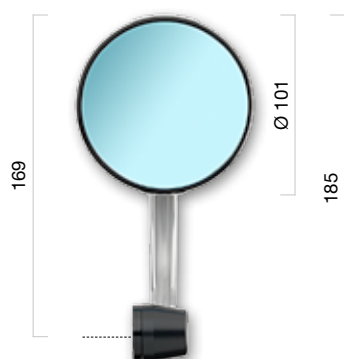

SPIRIT

Position	■	■
Biposition	BS191A	BS191B

SPORT NAKED CRUISER TOURING SCOOTER



CLASS RETRO



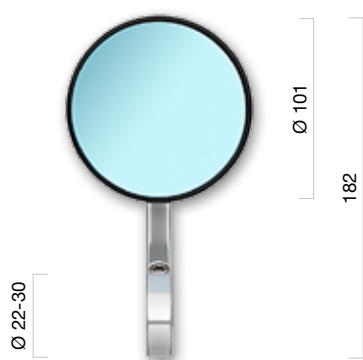

E-HOMOLOGATION | CONVEX AND ANTIGLARE GLASS
 STRUCTURAL ELEMENT IN ALUMINUM MACHINED FROM BILLET
 AERODYNAMIC POLYMER SHELL | 3D MACHINING | CLASSIC SOUL

SPORT	NAKED	CRUISER	TOURING	SCOOTER
-------	-------	---------	---------	---------



CLASS RETRO

Position	<input type="checkbox"/>	<input checked="" type="checkbox"/>
Biposition	BS144A	BS144B

Adaptors pages 48 - 57

MIRROR ADAPTORS

FOR BIKES WITHOUT FAIRINGS AND SCOOTERS

Brand	Model	Year	DRIFT BS400	ONE BS250 / BS251	VELOCE NAKED BS206	VELOCE L NAKED BS306	4D BS207 / BS208
Universal	All	All	BS411A	—	BS711A	BS711A	BS711A
Universal	All	All	BS411B	BS811B	BS711B	BS711B	BS711B
Eccetto							
Brand	Model	Year	DRIFT BS400	ONE BS250 / BS251	VELOCE NAKED BS206	VELOCE L NAKED BS306	4D BS207 / BS208
BMW®	F 800 R	09 - 14	BS411	BS812	BS711	BS711	BS711
BMW®	F 800 GS ADVENTURE	13 -	BS813 + BS411 / BS487 ¹	BS813	BS813 + BS711 / BS787 ¹	BS813 + BS711 / BS787 ¹	BS813 + BS711 / BS787 ¹
BMW®	HP2 MEGAMOTO	07 -	BS411	BS812	BS711	BS711	BS711
BMW®	K 1200 R	05 - 08	BS411	BS812	BS711	BS711	BS711
BMW®	K 1200 RS	97 - 06	—	—	BS714	BS714	BS714
BMW®	K 1300 R	09 -	BS411	BS812	BS711	BS711	BS711
BMW®	R 1150 R / R 1150 RS	00 - 07	—	—	BS714	BS714	BS714
BMW®	R 1150 GS	99 - 06	—	—	BS714	BS714	BS714
BMW®	R 1200 GS	04 - 12	BS487	BS812	BS711 / BS787 ¹	BS711 / BS787 ¹	BS711 / BS787 ¹
BMW®	R 1200 GS	13 -	BS487	BS813	BS711 / BS787 ¹	BS711 / BS787 ¹	BS711 / BS787 ¹
BMW®	R1200 GS ADVENTURE	10 - 13	BS487	BS812	BS787	BS787	BS787
BMW®	R1200 GS ADVENTURE	14 -	BS487	BS813	BS787	BS787	BS787
BMW®	R 1200 R / R CLASSIC	06 - 15	BS411	BS812	BS711	BS711	BS711
BMW®	C 600 SPORT / C 650 GT	12 -	—	—	—	—	BS790
BMW®	R nineT	14 -	BS411 / BS487 ¹	BS812	BS711 / BS787 ¹	BS711 / BS787 ¹	BS711 / BS787 ¹
BMW®	S 1000 R	14 -	BS411 / BS487 ¹	BS812	BS711 / BS787 ¹	BS711 / BS787 ¹	BS711 / BS787 ¹
BMW®	S 1000 XR	15 -	BS411 / BS487 ¹	BS812	BS711 / BS787 ¹	BS711 / BS787 ¹	BS711 / BS787 ¹
DUCATI®	MONSTER 696	08 -	BS415	BS815	BS715	BS715	BS715
DUCATI®	MONSTER 796	10 -	BS415	BS815	BS715	BS715	BS715
DUCATI®	MONSTER 1100 / 1100 EVO	09 -	BS415	BS815	BS715	BS715	BS715
DUCATI®	MONSTER 821	14 -	BS487	BS815	BS715 / BS787 ¹	BS715 / BS787 ¹	BS715 / BS787 ¹
DUCATI®	MONSTER 1200	14 -	BS415	BS815	BS715	BS715	BS715
DUCATI®	MULTISTRADA 1200 / 1200 S	15 -	—	—	BS736	BS736	BS736
DUCATI®	MULTISTRADA 1200 / 1200 S	10 - 14	BS416 / BS417 ²	—	BS716 / BS717 ²	BS716 / BS717 ²	BS716 / BS717 ²
DUCATI®	STREETFIGHTER	09 -	BS415	BS815	BS715	BS715	BS715
DUCATI®	STREETFIGHTER 848	13 -	BS415	BS815	BS715	BS715	BS715
DUCATI®	DIAVEL	10 -	BS487	BS815	BS787	BS787	BS787
HARLEY-DAVIDSON®	All	All	BS414	Inclusi	BS714	BS714	BS714
HONDA®	CB 650 F	15 -	BS487	BS811	BS711 / BS787 ¹	BS711 / BS787 ¹	BS711 / BS787 ¹
HONDA®	CB 1000 R	13 -	BS487	BS811	BS711 / BS787 ¹	BS711 / BS787 ¹	BS711 / BS787 ¹
HONDA®	NC700X	12 -	BS487	BS811	BS711 / BS787 ¹	BS711 / BS787 ¹	BS711 / BS787 ¹
HONDA®	INTEGRA	12 -	BS487	BS811	BS711 / BS787 ¹	BS711 / BS787 ¹	BS711 / BS787 ¹
KAWASAKI®	ER-6N	12 -	BS487	BS811	BS711 / BS787 ¹	BS711 / BS787 ¹	BS711 / BS787 ¹
KAWASAKI®	Z300	15 -	BS411	BS811	BS711 / BS787 ¹	BS711 / BS787 ¹	BS711 / BS787 ¹
KAWASAKI®	Z750R	11 -	BS487	BS811	BS787	BS787	BS787
KAWASAKI®	Z800	13 -	BS487	BS811	BS787	BS787	BS787
KAWASAKI®	Z1000	10 - 13	BS487	BS811	BS787	BS787	BS787
KAWASAKI®	Z1000	14 -	BS487	BS811	BS787	BS787	BS787
KAWASAKI®	VERSYS 1000 ABS	12 -	BS487	BS811	BS711 / BS787 ¹	BS711 / BS787 ¹	BS711 / BS787 ¹
MV AGUSTA®	BRUTALE 675	12 -	BS411	BS811	BS711	BS711	BS711
MV AGUSTA®	BRUTALE 800 / 1090	13 - 15	BS411	BS811	BS711	BS711	BS711
MV AGUSTA®	BRUTALE (Other models)	All	—	—	BS730	BS730	BS730
MV AGUSTA®	RIVALE 800 EAS	13 - 15	BS871 + BS411 / BS487 ^{2/1}	BS871 ²	BS871 ²	BS871 ²	BS871 ²
			BS870 + BS411 / BS487 ^{2/1}	BS870 ²	BS870 ²	BS870 ²	BS870 ²
SUZUKI®	GSF 600 BANDIT	00 - 05	BS487	BS811	BS787	BS787	BS787
SUZUKI®	GSF 1200 BANDIT	01 - 06	BS487	BS811	BS787	BS787	BS787
TRIUMPH®	STREET TRIPLE RX	15 -	BS411	BS811	BS711 / BS787 ¹	BS711 / BS787 ¹	BS711 / BS787 ¹
TRIUMPH®	STREET TRIPLE / R	13 -	BS487	BS811	BS711 / BS787 ¹	BS711 / BS787 ¹	BS711 / BS787 ¹
TRIUMPH®	TIGER 800 / EXPLORER	11 -	BS487	BS811	BS711 / BS787 ¹	BS711 / BS787 ¹	BS711 / BS787 ¹
TRIUMPH®	THRUXTON	15 -	BS414	BS414	BS804	BS804	BS804
TRIUMPH®	BONNEVILLE T100	08 -	BS414	BS414	BS804	BS804	BS804
YAMAHA®	XV950R	14 -	BS411/BS487 ¹	BS811	BS711 / BS787 ¹	BS711 / BS787 ¹	BS711 / BS787 ¹
YAMAHA®	T-MAX 500	08 - 11	—	—	BS775 / BS786 ⁴	BS775 / BS786 ⁴	BS775 / BS786 ⁴
YAMAHA®	T-MAX 530	12 -	—	—	BS775 / BS805 ⁴	BS775 / BS805 ⁴	BS775 / BS805 ⁴

¹ BS787 (h 57.5 mm) can be replaced by BS711 / BS715 (h 41.5 mm). BS487 (h 57 mm) can be replaced by BS411 (h 39 mm). Chose the one which corresponds to your riding style.

² BS716B left, BS717B right. BS416 left, BS417 right. BS870 left, BS871 right. BS870 / BS871 compatible with the OEM hand-protectors.

³ For Harley Davidson use only the BS251. Adaptors are included.

⁴ BS786B / BS805B fairing mirror adapter. BS775B handlebar mirror adapter: We recommend mirror hole caps BS522B for T-MAX 500 and BS806A for T-MAX 530.

MIRROR ADAPTORS

FOR BIKES WITHOUT FAIRINGS AND SCOOTERS

Brand	Model	Year	RADIAL BS130	ELISSE BS171 / BS172	LINEA BS196	DYNAMIC BS080
Universal	All	All	BS711A	BS711A	BS711A	BS711A
Universal	All	All	BS711B	BS711B	BS711B	BS711B
Except						
Brand	Model	Year	RADIAL BS130	ELISSE BS171 / BS172	LINEA BS196	DYNAMIC BS080
BMW®	F 800 R	09 - 14	BS711	BS711	BS711	BS711
BMW®	F 800 GS ADVENTURE	13 -	BS813 + BS711 / BS787 ¹	BS813 + BS711 / BS787 ¹	BS813 + BS711 / BS787 ¹	BS813 + BS711 / BS787 ¹
BMW®	HP2 MEGAMOTO	07 -	BS711	BS711	BS711	BS711
BMW®	K 1200 R	05 - 08	BS711	BS711	BS711	BS711
BMW®	K 1200 RS	97 - 06	BS714	BS714	BS714	BS714
BMW®	K 1300 R	09 -	BS711	BS711	BS711	BS711
BMW®	R 1150 R / R 1150 RS	00 - 07	BS714	BS714	BS714	BS714
BMW®	R 1150 GS	99 - 06	BS714	BS714	BS714	BS714
BMW®	R 1200 GS	04 - 12	BS711 / BS787 ¹	BS711 / BS787 ¹	BS711 / BS787 ¹	BS711 / BS787 ¹
BMW®	R 1200 GS	13 -	BS711 / BS787 ¹	BS711 / BS787 ¹	BS711 / BS787 ¹	BS711 / BS787 ¹
BMW®	R1200 GS ADVENTURE	10 - 13	BS787	BS787	BS787	BS787
BMW®	R1200 GS ADVENTURE	14 -	BS787	BS787	BS787	BS787
BMW®	R 1200 R / R CLASSIC	06 - 15	BS711	BS711	BS711	BS711
BMW®	C 600 SPORT / C 650 GT	12 -	BS790	BS790	BS790	-
BMW®	R nineT	14 -	BS711 / BS787 ¹	BS711 / BS787 ¹	BS711 / BS787 ¹	BS711 / BS787 ¹
BMW®	S 1000 R	14 -	BS711 / BS787 ¹	BS711 / BS787 ¹	BS711 / BS787 ¹	BS711 / BS787 ¹
BMW®	S 1000 XR	14 -	BS711 / BS787 ¹	BS711 / BS787 ¹	BS711 / BS787 ¹	BS711 / BS787 ¹
DUCATI®	MONSTER 696	08 -	BS715	BS715	BS715	BS715
DUCATI®	MONSTER 796	10 -	BS715	BS715	BS715	BS715
DUCATI®	MONSTER 1100 / 1100 EVO	09 -	BS715	BS715	BS715	BS715
DUCATI®	MONSTER 821	14 -	BS715 / BS787 ¹	BS715 / BS787 ¹	BS715 / BS787 ¹	BS715 / BS787 ¹
DUCATI®	MONSTER 1200	14 -	BS715	BS715	BS715	BS715
DUCATI®	MULTISTRADA 1200 / 1200 S	15 -	BS736	BS736	BS736	BS736
DUCATI®	MULTISTRADA 1200 / 1200 S	10 - 14	BS716 / BS717 ²	BS716 / BS717 ²	BS716 / BS717 ²	BS716 / BS717 ²
DUCATI®	STREETFIGHTER	09 -	BS715	BS715	BS715	BS715
DUCATI®	STREETFIGHTER 848	13 -	BS715	BS715	BS715	BS715
DUCATI®	DIAVEL	10 -	BS787	BS787	BS787	BS787
HARLEY-DAVIDSON®	All	All	BS714	BS714	BS714	BS714
HONDA®	CB 650 F	15 -	BS711 / BS787 ¹	BS711 / BS787 ¹	BS711 / BS787 ¹	BS711 / BS787 ¹
HONDA®	CB 1000 R	13 -	BS711 / BS787 ¹	BS711 / BS787 ¹	BS711 / BS787 ¹	BS711 / BS787 ¹
HONDA®	NC700X	12 -	BS711 / BS787 ¹	BS711 / BS787 ¹	BS711 / BS787 ¹	BS711 / BS787 ¹
HONDA®	INTEGRA	12 -	BS711 / BS787 ¹	BS711 / BS787 ¹	BS711 / BS787 ¹	BS711 / BS787 ¹
KAWASAKI®	ER-6N	12 -	BS711 / BS787 ¹	BS711 / BS787 ¹	BS711 / BS787 ¹	BS711 / BS787 ¹
KAWASAKI®	Z300	15 -	BS711 / BS787 ¹	BS711 / BS787 ¹	BS711 / BS787 ¹	BS711 / BS787 ¹
KAWASAKI®	Z750R	11 -	BS787	BS787	BS787	BS787
KAWASAKI®	Z800	13 -	BS787	BS787	BS787	BS787
KAWASAKI®	Z1000	10 - 13	BS787	BS787	BS787	BS787
KAWASAKI®	Z1000	14 -	BS787	BS787	BS787	BS787
KAWASAKI®	VERSYS 1000 ABS	12 -	BS711 / BS787 ¹	BS711 / BS787 ¹	BS711 / BS787 ¹	BS711 / BS787 ¹
MV AGUSTA®	BRUTALE 675	12 -	BS711	BS711	BS711	BS711
MV AGUSTA®	BRUTALE 800 / 1090	13 - 15	BS711	BS711	BS711	BS711
MV AGUSTA®	BRUTALE (Other models)	All	BS730	BS730	BS730	BS730
MV AGUSTA®	RIVALE 800 EAS	13 - 15	BS871 ² BS870 ²	BS871 ² BS870 ²	BS871 ² BS870 ²	BS871 ² BS870 ²
SUZUKI®	GSF 600 BANDIT	00 - 05	BS787	BS787	BS787	BS787
SUZUKI®	GSF 1200 BANDIT	01 - 06	BS787	BS787	BS787	BS787
TRIUMPH®	STREET TRIPLE RX	15 -	BS711 / BS787 ¹	BS711 / BS787 ¹	BS711 / BS787 ¹	BS711 / BS787 ¹
TRIUMPH®	STREET TRIPLE / R	13 -	BS711 / BS787 ¹	BS711 / BS787 ¹	BS711 / BS787 ¹	BS711 / BS787 ¹
TRIUMPH®	TIGER 800 / EXPLORER	11 -	BS711 / BS787 ¹	BS711 / BS787 ¹	BS711 / BS787 ¹	BS711 / BS787 ¹
TRIUMPH®	THRUXTON	15 -	BS804	BS804	BS804	BS804
TRIUMPH®	BONNEVILLE T100	08 -	BS804	BS804	BS804	BS804
YAMAHA®	XV950R	14 -	BS711 / BS787 ¹	BS711 / BS787 ¹	BS711 / BS787 ¹	BS711 / BS787 ¹
YAMAHA®	T-MAX 500	08 - 11	BS775 / BS786 ⁴	BS775 / BS786 ⁴	BS775 / BS786 ⁴	BS775 / BS786 ⁴
YAMAHA®	T-MAX 530	12 -	BS775 / BS805 ⁴	BS775 / BS805 ⁴	BS775 / BS805 ⁴	BS775 / BS805 ⁴

¹ BS787 (h 57.5 mm) can be replaced by BS711 / BS715 (h 41.5 mm). BS487 (h 57 mm) can be replaced by BS411 (h 39 mm). Chose the one which corresponds to your riding style.

² BS716B left, BS717B right. BS416 left, BS417 right. BS870 left, BS871 right. BS870 / BS871 compatible with the OEM hand-protectors.

³ For Harley Davidson use only the BS251. Adaptors are included.

⁴ BS786B / BS805B fairing mirror adapter. BS775B handlebar mirror adapter: We recommend mirror hole caps BS522B for T-MAX 500 and BS806A for T-MAX 530.

MIRROR ADAPTORS

FOR BIKES WITHOUT FAIRINGS AND SCOOTERS

Brand	Model	Year	TOMOK BS160 / BS162	CIRCUIT 851 BS010 / BS011	CIRCUIT 959 BS203 / BS204	CIRCUIT 744 BS201 / BS202	LIMIT NAKED BS154
Universal	All	All	BS711A	Included	Included	BS711A	BS711A
Universal	All	All	BS711B	Included	Included	BS711B	BS711B
Except							
Brand	Model	Year	TOMOK BS160 / BS162	CIRCUIT 851 BS010 / BS011	CIRCUIT 959 BS203 / BS204	CIRCUIT 744 BS201 / BS202	LIMIT NAKED BS154
BMW®	F 800 R	09 - 14	BS711	BS714	BS714	BS711	BS711
BMW®	F 800 GS ADVENTURE	13 -	BS813 + BS711 / BS787 ¹	BS813	BS813	BS813 + BS711 / BS787 ¹	BS813 + BS711 / BS787 ¹
BMW®	HP2 MEGAMOTO	07 -	BS711	BS714	BS714	BS711	BS711
BMW®	K 1200 R	05 - 08	BS711	BS714	BS714	BS711	BS711
BMW®	K 1200 RS	97 - 06	BS714	BS714	BS714	BS714	BS714
BMW®	K 1300 R	09 -	BS711	BS714	BS714	BS711	BS711
BMW®	R 1150 R / R 1150 RS	00 - 07	BS714	—	—	BS714	BS714
BMW®	R 1150 GS	99 - 06	BS714	BS714	BS714	BS714	BS714
BMW®	R 1200 GS	04 - 12	BS711 / BS787 ¹	BS714	BS714	BS711 / BS787 ¹	BS711 / BS787 ¹
BMW®	R 1200 GS	13 -	BS711 / BS787 ¹	BS714	BS714	BS711 / BS787 ¹	BS711 / BS787 ¹
BMW®	R1200 GS ADVENTURE	10 - 13	BS787	BS714	BS714	BS787	BS787
BMW®	R1200 GS ADVENTURE	14 -	BS787	BS714	BS714	BS787	BS787
BMW®	R 1200 R / R CLASSIC	06 - 15	BS711	BS714	BS714	BS711	BS711
BMW®	C 600 SPORT / C 650 GT	12 -	BS790	—	—	BS790	BS790
BMW®	R nineT	14 -	BS711 / BS787 ¹	BS714	BS714	BS711 / BS787 ¹	BS711 / BS787 ¹
BMW®	S 1000 R	14 -	BS711 / BS787 ¹	BS714	BS714	BS711 / BS787 ¹	BS711 / BS787 ¹
BMW®	S 1000 XR	15 -	BS711 / BS787 ¹	BS714	BS714	BS711 / BS787 ¹	BS711 / BS787 ¹
DUCATI®	MONSTER 696	08 -	BS715	BS780	BS780	BS715	BS715
DUCATI®	MONSTER 796	10 -	BS715	BS780	BS780	BS715	BS715
DUCATI®	MONSTER 1100 / 1100 EVO	09 -	BS715	BS780	BS780	BS715	BS715
DUCATI®	MONSTER 821	14 -	BS715 / BS787 ¹	BS780	BS780	BS715 / BS787 ¹	BS715 / BS787 ¹
DUCATI®	MONSTER 1200	14 -	BS715	BS780	BS780	BS715	BS715
DUCATI®	MULTISTRADA 1200 / 1200 S	15 -	BS736	—	—	BS736	BS736
DUCATI®	MULTISTRADA 1200 / 1200 S	10 - 14	BS716 / BS717 ²	—	—	BS716 / BS717 ²	BS716 / BS717 ²
DUCATI®	STREETFIGHTER	09 -	BS715	BS780	BS780	BS715	BS715
DUCATI®	STREETFIGHTER 848	13 -	BS715	BS780	BS780	BS715	BS715
DUCATI®	DIAVEL	10 -	BS787	BS780	BS780	BS787	BS787
HARLEY-DAVIDSON®	All	All	BS714	BS760	—	BS714	BS714
HONDA®	CB 650 F	15 -	BS711 / BS787 ¹	Included	Included	BS711 / BS787 ¹	BS711 / BS787 ¹
HONDA®	CB 1000 R	13 -	BS711 / BS787 ¹	Included	Included	BS711 / BS787 ¹	BS711 / BS787 ¹
HONDA®	NC700X	12 -	BS711 / BS787 ¹	Included	Included	BS711 / BS787 ¹	BS711 / BS787 ¹
HONDA®	INTEGRA	12 -	BS711 / BS787 ¹	Included	Included	BS711 / BS787 ¹	BS711 / BS787 ¹
KAWASAKI®	ER-6N	12 -	BS711 / BS787 ¹	Included	Included	BS711 / BS787 ¹	BS711 / BS787 ¹
KAWASAKI®	Z300	15 -	BS711 / BS787 ¹	Included	Included	BS711 / BS787 ¹	BS711 / BS787 ¹
KAWASAKI®	Z750R	11 -	BS787	Included	Included	BS787	BS787
KAWASAKI®	Z800	13 -	BS787	Included	Included	BS787	BS787
KAWASAKI®	Z1000	10 - 13	BS787	Included	Included	BS787	BS787
KAWASAKI®	Z1000	14 -	BS787	Included	Included	BS787	BS787
KAWASAKI®	VERSYS 1000 ABS	12 -	BS711 / BS787 ¹	Included	Included	BS711 / BS787 ¹	BS711 / BS787 ¹
MV AGUSTA®	BRUTALE 675	12 -	BS711	Included	Included	BS711	BS711
MV AGUSTA®	BRUTALE 800 / 1090	13 - 15	BS711	Included	Included	BS711	BS711
MV AGUSTA®	BRUTALE (Other models)	All	BS730	BS730	BS730	BS730	BS730
MV AGUSTA®	RIVALE 800 EAS	13 - 15	BS871 ² BS870 ²	BS871 ² BS870 ²	BS871 ² BS870 ²	BS871 ² BS870 ²	BS871 ² BS870 ²
SUZUKI®	GSF 600 BANDIT	00 - 05	BS787	Included	Included	BS787	BS787
SUZUKI®	GSF 1200 BANDIT	01 - 06	BS787	Included	Included	BS787	BS787
TRIUMPH®	STREET TRIPLE RX	15 -	BS711 / BS787 ¹	Included	Included	BS711 / BS787 ¹	BS711 / BS787 ¹
TRIUMPH®	STREET TRIPLE / R	13 -	BS711 / BS787 ¹	Included	Included	BS711 / BS787 ¹	BS711 / BS787 ¹
TRIUMPH®	TIGER 800 / EXPLORER	11 -	BS711 / BS787 ¹	Included	Included	BS711 / BS787 ¹	BS711 / BS787 ¹
TRIUMPH®	THRUXTON	15 -	BS804	BS814	BS814	BS804	BS804
TRIUMPH®	BONNEVILLE T100	08 -	BS804	BS814	BS814	BS804	BS804
YAMAHA®	XV950R	14 -	BS711 / BS787 ¹	Included	Included	BS711 / BS787 ¹	BS711 / BS787 ¹
YAMAHA®	T-MAX 500	08 - 11	BS775 / BS786 ⁴	—	—	BS775 / BS786 ⁴	BS775 / BS786 ⁴
YAMAHA®	T-MAX 530	12 -	BS775 / BS805 ⁴	—	—	BS775 / BS805 ⁴	BS775 / BS805 ⁴

¹ BS787 (h 57.5 mm) can be replaced by BS711 / BS715 (h 41.5 mm). BS487 (h 57 mm) can be replaced by BS411 (h 39 mm). Chose the one which corresponds to your riding style.

² BS716B left, BS717B right. BS416 left, BS417 right. BS870 left, BS871 right. BS870 / BS871 compatible with the OEM hand-protectors.

³ For Harley Davidson use only the BS251. Adaptors are included.

⁴ BS786B / BS805B fairing mirror adapter. BS775B handlebar mirror adapter: We recommend mirror hole caps BS522B for T-MAX 500 and BS806A for T-MAX 530.

MIRROR ADAPTORS
 FOR BIKES WITHOUT FAIRINGS AND SCOOTERS

Adapters

■	■	Included
BS411A	BS411B	Screws M10x1,25x20 - M10x1,25x20SX - M10x20
BS414A	BS414B	Screws M8x50 - Lock Washer Ø 8 - Nut M8
BS415A	BS415B	Screws M8x20 - M8x20SX
BS416A	BS416B	Screws M10x1,25x30 - M8x20
BS417A	BS417B	Screws M10x1,25x30SX - M8x20
BS487A	BS487B	Screws M8x40 - M8x40SX - M10x1,25x40 - M10x1,25x40SX - M10x40
BS711A	BS711B	Screws M10x1,25x20 - M10x1,25x20SX - M10x20 - M6x16
—	BS714B	Screws M8x75 - M8x50 - M8x65 - M6x16 - Stud Bolt M8-M10
—	BS715B	Screws M8x25 - M8x25SX - M6x16
—	BS716B	Screws M10x1,25x30 - M6x16
—	BS717B	Screws M10x1,25x30SX - M6x16
—	BS730B	Screw M6x16
—	BS736B	Screws M10x1,25x30SX - Screws M10x1,25x30 - M6x16
—	BS760B	Screws M8x45 - Mirror shaft L 126 mm M8
—	BS770B	KIT
—	BS775B	KIT
BS780H	-	Stud Bolt M8 - M8SX
—	BS786B	KIT
—	BS787B	Screws M10x1,25x40 - M10x1,25x40SX - M8x40 - M8x40SX - M10x40 - M6x16
—	BS790B	Screws M6x25 - M6x30 - M6x20
—	BS804B	Screws M8x50 - M6x16 - Lock Washer Ø 8 - Nut M8
—	BS805B	Screws M6x20 - M5x12
—	BS811B	Stud Bolt M10x1,25/M10 + Stud Bolt M10x1,25/M10-SX
—	BS812B	Stud Bolt M10x1,25/M10
—	BS813B	Stud Bolt M10x1,25/M10 - Lock Washer Ø 10
—	BS814B	Stud Bolt M10x1,25/M6
—	BS815B	Stud BoltS M10x1,25/M8 - Stud Bolt M10x1,25/M8-SX
—	BS870B	Screws M6x20 - M5x10 - M6x16 - M10x1,25x20
—	BS871B	Screw M5x16 - M6x16 - M10x1,25x20



BS711B - BS714 - BS715 - BS736



BS770B



BS870



BS871

MIRROR ADAPTORS

FOR BIKES WITH FAIRINGS

Brand	Model	Year	VELOCE SPORT BS205	RADIAL BS130	ELISSE BS171 BS172	LIMIT SPORT BS150	CIRCUIT 744 BS201 BS202	LINEA BS196	TOMOK BS160 BS162
BMW®	S 1000 RR	10 -	BS785B	BS785B	BS785B	BS785B	BS785B	BS785B	BS785B
HONDA®	CBR 600 F	11 -	—	BS778B	BS778B	BS778B	BS778B	BS778B	BS778B
HONDA®	CBR 600 RR	03 - 08	BS721B	BS721B	BS721B	BS721B	BS721B	BS721B	BS721B
HONDA®	CBR 600 RR	09 -	BS778B	BS778B	BS778B	BS778B	BS778B	BS778B	BS778B
HONDA®	CBR 900 RR	02 - 04	BS721B	BS721B	BS721B	BS721B	BS721B	BS721B	BS721B
HONDA®	CBR 1000 RR	04 - 07	BS721B	BS721B	BS721B	BS721B	BS721B	BS721B	BS721B
KAWASAKI®	ER-6F	11 -	BS778B	BS778B	BS778B	BS778B	BS778B	BS778B	BS778B
KAWASAKI®	NINJA 300	15 -	BS779B	BS779B	BS779B	BS779B	BS779B	BS779B	BS779B
KAWASAKI®	NINJA 600 / 636 ZX-6R	05 - 08	BS721B	BS721B	BS721B	BS721B	BS721B	BS721B	BS721B
KAWASAKI®	NINJA 600 ZX-6R	09 -	BS779B	BS779B	BS779B	BS779B	BS779B	BS779B	BS779B
KAWASAKI®	NINJA 1000 ZX-10R	04 - 07	BS721B	BS721B	BS721B	BS721B	BS721B	BS721B	BS721B
SUZUKI®	GSF 600 S BANDIT	00 - 05	BS726B	BS726B	BS726B	BS726B	BS726B	BS726B	BS726B
SUZUKI®	GSF 1200 S BANDIT	01 - 06	BS726B	BS726B	BS726B	BS726B	BS726B	BS726B	BS726B
SUZUKI®	GSF 650 / 1250 S BANDIT	07 -	BS778B	BS778B	BS778B	BS778B	BS778B	BS778B	BS778B
SUZUKI®	GSX F 650 / 1250 BANDIT	08 -	BS778B	BS778B	BS778B	BS778B	BS778B	BS778B	BS778B
SUZUKI®	GSX FA 1250 BANDIT	10 -	BS778B	BS778B	BS778B	BS778B	BS778B	BS778B	BS778B
SUZUKI®	GSX R 600	01 - 05	BS726B	BS726B	BS726B	BS726B	BS726B	BS726B	BS726B
SUZUKI®	GSX R 750	00 - 05	BS726B	BS726B	BS726B	BS726B	BS726B	BS726B	BS726B
SUZUKI®	GSX R 1000	00 - 04	BS726B	BS726B	BS726B	BS726B	BS726B	BS726B	BS726B
SUZUKI®	SV 650 S	03 -	BS726B	BS726B	BS726B	BS726B	BS726B	BS726B	BS726B
SUZUKI®	SV 1000 S	03 - 06	BS726B	BS726B	BS726B	BS726B	BS726B	BS726B	BS726B
TRIUMPH®	DAYTONA 675	06 - 08	BS724B	BS724B	BS724B	BS724B	BS724B	BS724B	BS724B
TRIUMPH®	DAYTONA 675	09 - 12	BS777B	BS777B	BS777B	BS777B	BS777B	BS777B	BS777B
TRIUMPH®	DAYTONA 675 R	11 - 12	BS777B	BS777B	BS777B	BS777B	BS777B	BS777B	BS777B
TRIUMPH®	DAYTONA 675 R	13 -	BS791B	BS791B	BS791B	BS791B	BS791B	BS791B	BS791B
YAMAHA®	FZ1 FAZER	06 -	BS734B	BS734B	BS734B	BS734B	BS734B	BS734B	BS734B
YAMAHA®	FZ6 FAZER	04 - 08	BS724B	BS724B	BS724B	BS724B	BS724B	BS724B	BS724B
YAMAHA®	YZF-R1	02 - 08	BS724B	BS724B	BS724B	BS724B	BS724B	BS724B	BS724B
YAMAHA®	YZF-R1	09 - 14	BS777B	BS777B	BS777B	BS777B	BS777B	BS777B	BS777B
YAMAHA®	YZF-R6	03 - 07	BS724B	BS724B	BS724B	BS724B	BS724B	BS724B	BS724B
YAMAHA®	YZF-R6	08 -	BS771B	BS771B	BS771B	BS771B	BS771B	BS771B	BS771B

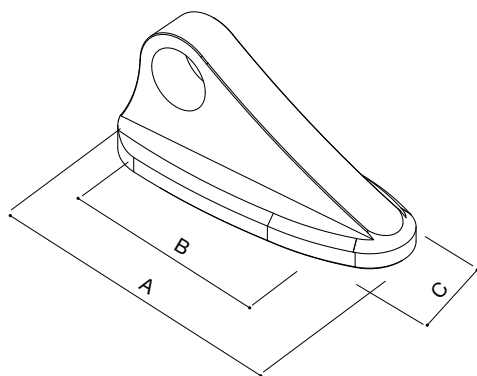

Adaptors

■	A (mm)	B (mm)	C (mm)	■	A (mm)	B (mm)	C (mm)
BS721B	60	40	28	BS777B	48	28 - 30	20
BS724B	51	28.5	20	BS778B	60	40 - 42	20
BS725B	48	28 - 30	20	BS779B	67	47	20
BS726B	72	42	28	BS785B	48	28 - 30	20
BS734B	71.5	40	27	BS788B	53.5	33.5	31.2
BS735B	60	36 - 38	20	BS789B	52.3	37	20
BS743B	60	40 - 42	20	BS791B	67	47	20
BS771B	55	28	27	BS808B	67	47	20
BS772B	78.3	44	34.6				

MIRROR ADAPTORS “VELOCE L”
 WITH INTEGRATED MARKER LIGHT

Brand	Model	Year	VELOCE L SPORT BS305
APRILIA®	RSV4	09 -	BS735B
DUCATI®	899 PANIGALE	14 -	BS789B
DUCATI®	1199 PANIGALE / PANIGALE S	12 -	BS789B
DUCATI®	848 / 1098 / 1198	06 -	BS788B
HONDA®	CBR 1000 RR	08 -	BS772B
KAWASAKI®	NINJA 1000 ZX-10R	08 - 10	BS743B
KAWASAKI®	NINJA 1000 ZX-10R	11 -	BS808B
MV AGUSTA®	F3 675	12 -	BS743B
MV AGUSTA®	F4 1000	10 -	BS743B
SUZUKI®	GSX R 600	06 -	BS743B
SUZUKI®	GSX R 750	06 -	BS743B
SUZUKI®	GSX R 1000	05 -	BS743B
YAMAHA®	YZF-R1	15 -	BS725B



BAR END MIRROR ADAPTORS

NAKED BIKES

Brand	Model	Year	SPIRIT BS191	SPY-R 60 BS185	SPY-R 80 BS285	SPY-R 100 BS294	SPY-Q BS186
Universal	All	All	Included	LP200B	LP200B	LP200B	LP200B
Except							
Brand	Model	Year	SPIRIT BS191	SPY-R 60 BS185	SPY-R 80 BS285	SPY-R 100 BS294	SPY-Q BS186
BMW®	F 800 R	09 - 14	LP322B	LP322B	LP322B	LP322B	LP322B
BMW®	HP2 MEGAMOTO	07 -	Included	LP200B	LP200B	LP200B	LP200B
BMW®	K 1200 R	05 - 08	LP305B	LP305B	LP305B	LP305B	LP305B
BMW®	K 1300 R	09 -	LP320B	LP320B	LP320B	LP320B	LP320B
BMW®	R 1200 GS	13 -	—	LP324B	LP324B	LP324B	LP324B
BMW®	R 1200 GS	04 - 12	—	—	—	—	—
BMW®	R1200 GS ADVENTURE	14 -	—	LP324B	LP324B	LP324B	LP324B
BMW®	R1200 GS ADVENTURE	10 - 13	—	—	—	—	—
BMW®	R 1200 R / R CLASSIC	15 -	LP324B	LP324B	LP324B	LP324B	LP324B
BMW®	R 1200 R / R CLASSIC	06 - 14	LP320B	LP320B	LP320B	LP320B	LP320B
BMW®	C 600 SPORT / C 650 GT	12 -	LP323B	LP323B	LP323B	LP323B	LP323B
BMW®	R nineT	14 -	LP325B	LP325B	LP325B	LP325B	LP325B
BMW®	S 1000 XR	15 -	—	LP324B ³	LP324B ³	LP324B ³	LP324B ³
BMW®	S 1000 R	14 -	LP325B	LP325B	LP325B	LP325B	LP325B
DUCATI®	MONSTER 696	08 -	Included	LP200B	LP200B	LP200B	LP200B
DUCATI®	MONSTER 796	10 -	Included	LP200B	LP200B	LP200B	LP200B
DUCATI®	MONSTER 1100 / 1100 EVO	09 -	Included	LP200B	LP200B	LP200B	LP200B
DUCATI®	MONSTER 821	14 -	Included	LP200B	LP200B	LP200B	LP200B
DUCATI®	MONSTER 1200	14 -	Included	LP200B	LP200B	LP200B	LP200B
DUCATI®	MULTISTRADA 1200 S	10 -	Included	LP200B	LP200B	LP200B	LP200B
DUCATI®	STREETFIGHTER / 848	09 -	Included	LP200B	LP200B	LP200B	LP200B
DUCATI®	DIAVEL	10 -	Included	LP200B	LP200B	LP200B	LP200B
HARLEY-DAVIDSON®	All	All	LP400B	LP400B	LP400B	LP400B	LP400B
HONDA®	NC700X	12 -	Included	LP200B	LP200B	LP200B	LP200B
HONDA®	INTEGRA	12 -	Included	LP200B	LP200B	LP200B	LP200B
KAWASAKI®	ER-6N	12 -	LP305B	LP305B	LP305B	LP305B	LP305B
KAWASAKI®	Z300	15 -	LP305B	LP305B	LP305B	LP305B	LP305B
KAWASAKI®	Z750R	11 -	LP305B	LP305B	LP305B	LP305B	LP305B
KAWASAKI®	Z800	13 -	LP305B	LP305B	LP305B	LP305B	LP305B
KAWASAKI®	Z1000	10 -	LP305B	LP305B	LP305B	LP305B	LP305B
KAWASAKI®	VERSYS 1000 ABS	12 -	LP305B	LP305B	LP305B	LP305B	LP305B
MV AGUSTA®	BRUTALE 675	12 -	LP335B	LP335B	LP335B	LP335B	LP335B
MV AGUSTA®	BRUTALE 800 / 1090	13 - 15	LP335B	LP335B	LP335B	LP335B	LP335B
MV AGUSTA®	BRUTALE (Other models)	All	Included	LP200B	LP200B	LP200B	LP200B
MV AGUSTA®	RIVALE 800 EAS ¹	14 - 15	LP335B	LP335B	LP335B	LP335B	LP335B
TRIUMPH®	TIGER 800	11 -	Included	Included	Included	Included	Included
TRIUMPH®	TIGER EXPLORER	12 -	Included	Included	Included	Included	Included
TRIUMPH®	SPEED TRIPLE 1050 / 1050 R	11 - 15	LP310B	LP310B	LP310B	LP310B	LP310B
TRIUMPH®	STREET TRIPLE / R / RX	13 -	—	Included	Included	Included	Included
TRIUMPH®	STREET TRIPLE / R	07 - 12	LP310B	LP310B	LP310B	LP310B	LP310B
TRIUMPH®	SCRAMBLER 900	15 -	—	BS816B	BS816B	BS816B	BS816B
TRIUMPH®	THRUXTON	15 -	—	BS816B	BS816B	BS816B	BS816B
TRIUMPH®	BONNEVILLE T100	14 -	—	BS816B	BS816B	BS816B	BS816B
YAMAHA®	XJR 1300	15 -	LP300B	LP300B	LP300B	LP300B	LP300B
YAMAHA®	MT-09 TRACER / FJ-09 ¹	15 -	LP335B	LP335B	LP335B	LP335B	LP335B
YAMAHA®	MT-09 / FZ-09	13 -	LP300B	LP300B	LP300B	LP300B	LP300B
YAMAHA®	MT-07 / FZ-07	14 -	LP300B	LP300B	LP300B	LP300B	LP300B
YAMAHA®	XJ6	08 -	LP300B	LP300B	LP300B	LP300B	LP300B
YAMAHA®	T-MAX 500	08 - 11	LP300B	LP300B	LP300B	LP300B	LP300B
YAMAHA®	T-MAX 530	12 -	LP300B	LP300B	LP300B	LP300B	LP300B

¹ Do not fit with the original hand-protectors.

BAR END MIRROR ADAPTORS
NAKED BIKES

Brand	Model	Year	SPY-ARM 80 BS300	SPY-ARM 100 BS303	CLASS RETRO BS144	REVERSE RETRO BS070
Universal	All	All	LP200B	LP200B	MA534 / MA533	MA534 / MA533
Except						
Brand	Model	Year	SPY-ARM 80 BS300	SPY-ARM 100 BS303	CLASS RETRO BS144	REVERSE RETRO BS070
BMW®	F 800 R	09 - 14	LP322B	LP322B	LP322 + MA533	LP322 + MA533
BMW®	HP2 MEGAMOTO	07 -	LP200B	LP200B	MA534 / MA533	MA534 / MA533
BMW®	K 1200 R	05 - 08	LP305B	LP305B	MA534 / MA533	MA534 / MA533
BMW®	K 1300 R	09 -	LP320B	LP320B	—	—
BMW®	R 1200 GS	13 -	LP324B	LP324B	LP324 + MA533	LP324 + MA533
BMW®	R 1200 GS	04 - 12	—	—	MA525	MA525
BMW®	R1200 GS ADVENTURE	14 -	LP324B	LP324B	LP324 + MA533	LP324 + MA533
BMW®	R1200 GS ADVENTURE	10 - 13	—	—	MA525	MA525
BMW®	R 1200 R / R CLASSIC	15 -	LP324B	LP324B	LP324 + MA533	LP324 + MA533
BMW®	R 1200 R / R CLASSIC	06 - 14	LP320B	LP320B	—	—
BMW®	C 600 SPORT / C 650 GT	12 -	LP323B	LP323B	LP323 + MA533	LP323 + MA533
BMW®	R nineT	14 -	LP325B	LP325B	LP325B + MA534 / MA533	LP325B + MA534 / MA533
BMW®	S 1000 XR	15 -	LP324B / BS755B ³	LP324B / BS755B ³	LP324B / BS755B ³	LP324B / BS755B ³
BMW®	S 1000 R	14 -	LP325B	LP325B	LP321B + MA534 / MA533	LP321B + MA534 / MA533
DUCATI®	MONSTER 696	08 -	LP200B	LP200B	MA534 / MA533	MA534 / MA533
DUCATI®	MONSTER 796	10 -	LP200B	LP200B	MA534 / MA533	MA534 / MA533
DUCATI®	MONSTER 1100 / 1100 EVO	09 -	LP200B	LP200B	MA534 / MA533	MA534 / MA533
DUCATI®	MONSTER 821	14 -	LP200B	LP200B	MA534 / MA533	MA534 / MA533
DUCATI®	MONSTER 1200	14 -	LP200B	LP200B	MA534 / MA533	MA534 / MA533
DUCATI®	MULTISTRADA 1200 S	10 -	LP200B	LP200B	MA534 / MA533	MA534 / MA533
DUCATI®	STREETFIGHTER / 848	09 -	LP200B	LP200B	MA534 / MA533	MA534 / MA533
DUCATI®	DIAVEL	10 -	LP200B	LP200B	MA534 / MA533	MA534 / MA533
HARLEY-DAVIDSON®	All	All	LP400B	LP400B	—	—
HONDA®	NC700X	12 -	LP200B	LP200B	MA534 / MA533	MA534 / MA533
HONDA®	INTEGRA	12 -	LP200B	LP200B	MA534 / MA533	MA534 / MA533
KAWASAKI®	ER-6N	12 -	LP305B	LP305B	—	—
KAWASAKI®	Z300	15 -	LP305B	LP305B	—	—
KAWASAKI®	Z750R	11 -	LP305B	LP305B	—	—
KAWASAKI®	Z800	13 -	LP305B	LP305B	—	—
KAWASAKI®	Z1000	10 -	LP305B	LP305B	—	—
KAWASAKI®	VERSYS 1000 ABS	12 -	LP305B	LP305B	—	—
MV AGUSTA®	BRUTALE 675	12 -	LP335B	LP335B	MA534 / MA533	MA534 / MA533
MV AGUSTA®	BRUTALE 800 / 1090	13 - 15	LP335B	LP335B	MA534 / MA533	MA534 / MA533
MV AGUSTA®	BRUTALE (Other models)	All	LP200B	LP200B	MA534 / MA533	MA534 / MA533
MV AGUSTA®	RIVALE 800 EAS ²	14 - 15	LP335B	LP335B	MA534 / MA533	MA534 / MA533
TRIUMPH®	TIGER 800	11 -	Included	Included	MA534 / MA533	MA534 / MA533
TRIUMPH®	TIGER EXPLORER	12 -	Included	Included	MA534 / MA533	MA534 / MA533
TRIUMPH®	SPEED TRIPLE 1050 / 1050 R	11 - 15	LP310B	LP310B	—	—
TRIUMPH®	STREET TRIPLE / R / RX	13 -	Included	Included	—	—
TRIUMPH®	STREET TRIPLE / R	07 - 12	LP310B	LP310B	—	—
TRIUMPH®	SCRAMBLER 900	15 -	BS816B	BS816B	—	—
TRIUMPH®	THRUXTON	15 -	BS816B	BS816B	BS816B + MA534 / MA533	BS816B + MA534 / MA533
TRIUMPH®	BONNEVILLE T100	14 -	BS816B	BS816B	BS816B + MA534 / MA533	BS816B + MA534 / MA533
YAMAHA®	XJR 1300	15 -	LP300B	LP300B	MA534 / MA533 ¹	MA534 / MA533 ¹
YAMAHA®	MT-09 TRACER / FJ-09 ²	15 -	LP335B	LP335B	MA534 / MA533 ¹	MA534 / MA533 ¹
YAMAHA®	MT-09 / FZ-09	13 -	LP300B	LP300B	MA534 / MA533 ¹	MA534 / MA533 ¹
YAMAHA®	MT-07 / FZ-07	14 -	LP300B	LP300B	MA534 / MA533 ¹	MA534 / MA533 ¹
YAMAHA®	XJ6	08 -	LP300B	LP300B	MA534 / MA533 ¹	MA534 / MA533 ¹
YAMAHA®	T-MAX 500	08 - 11	LP300B	LP300B	MA534 / MA533 ¹	MA534 / MA533 ¹
YAMAHA®	T-MAX 530	12 -	LP300B	LP300B	MA534 / MA533 ¹	MA534 / MA533 ¹

¹ Adapter MA600 is required, see page 93.

² Do not fit with the original hand-protectors.

³ The adaptor BS755B is compatible with the OEM hand-protectors and permits the mounting of the handlebar end mirrors BS300 / BS303 / BS070 / BS144. With the LP324 adaptor the removal of the OEM hand-protectors is required.

BAR END MIRROR ADAPTORS

SPORTSBIKES (WITH FAIRINGS)

Brand	Model	Year	SPY-R 60 BS185	SPY-R 80 BS285	SPY-R 100 BS294	SPY-Q BS186	CLASS RETRO BS144	REVERSE RETRO BS070
APRILIA®	RSV4	09 -	LP200B	LP200B	LP200B	LP200B	MA534 / MA533	MA534 / MA533
BMW®	S 1000 RR	10 -	LP321B	LP321B	LP321B	LP321B	LP321 + MA533	LP321 + MA533
DUCATI®	848 / 1098 / 1198	06 -	LP200B	LP200B	LP200B	LP200B	MA534 / MA533	MA534 / MA533
HONDA®	CBR 600 F	99 - 06	LP200B	LP200B	LP200B	LP200B	MA534 / MA533	MA534 / MA533
HONDA®	CBR 600 F	11 -	LP200B	LP200B	LP200B	LP200B	MA534 / MA533	MA534 / MA533
HONDA®	CBR 600 RR	03 -	LP200B	LP200B	LP200B	LP200B	MA534 / MA533	MA534 / MA533
HONDA®	CBR 900 RR	02 - 04	LP200B	LP200B	LP200B	LP200B	MA534 / MA533	MA534 / MA533
HONDA®	CBR 1000 RR	04 -	LP200B	LP200B	LP200B	LP200B	MA534 / MA533	MA534 / MA533
HONDA®	HORNET 600 S	02 - 04	LP200B	LP200B	LP200B	LP200B	MA534 / MA533	MA534 / MA533
HONDA®	VTR 1000 SP-1 / SP-2	00 - 06	LP200B	LP200B	LP200B	LP200B	MA534 / MA533	MA534 / MA533
KAWASAKI®	ER-6F	06 -	LP305B	LP305B	LP305B	LP305B	—	—
KAWASAKI®	NINJA 300	15 -	LP305B	LP305B	LP305B	LP305B	—	—
KAWASAKI®	NINJA 600 / 636 ZX-6R	00 -	LP305B	LP305B	LP305B	LP305B	—	—
KAWASAKI®	NINJA 600 ZX-6R	09 -	LP305B	LP305B	LP305B	LP305B	—	—
KAWASAKI®	NINJA 900 ZX-9R	98 - 05	LP305B	LP305B	LP305B	LP305B	—	—
KAWASAKI®	NINJA 1000 ZX-10R	04 -	LP305B	LP305B	LP305B	LP305B	—	—
MV AGUSTA®	F3 675	12 -	LP200B	LP200B	LP200B	LP200B	MA534 / MA533	MA534 / MA533
MV AGUSTA®	F4 1000	10 -	LP200B	LP200B	LP200B	LP200B	MA534 / MA533	MA534 / MA533
SUZUKI®	GSF 600 S BANDIT	00 - 05	LP200B	LP200B	LP200B	LP200B	MA534 / MA533	MA534 / MA533
SUZUKI®	GSF 1200 S BANDIT	01 - 06	LP200B	LP200B	LP200B	LP200B	MA534 / MA533	MA534 / MA533
SUZUKI®	GSF 650 / 1250 S BANDIT	07 -	LP200B	LP200B	LP200B	LP200B	MA534 / MA533	MA534 / MA533
SUZUKI®	GSX F 650 / 1250 BANDIT	08 -	LP200B	LP200B	LP200B	LP200B	MA534 / MA533	MA534 / MA533
SUZUKI®	GSX FA 1250 BANDIT	10 -	LP200B	LP200B	LP200B	LP200B	MA534 / MA533	MA534 / MA533
SUZUKI®	GSX R 600	01 -	LP200B	LP200B	LP200B	LP200B	MA534 / MA533	MA534 / MA533
SUZUKI®	GSX R 750	99 -	LP200B	LP200B	LP200B	LP200B	MA534 / MA533	MA534 / MA533
SUZUKI®	GSX R 1000	00 -	LP200B	LP200B	LP200B	LP200B	MA534 / MA533	MA534 / MA533
SUZUKI®	SV 650 S	03 -	LP200B	LP200B	LP200B	LP200B	MA534 / MA533	MA534 / MA533
SUZUKI®	SV 1000 S	03 - 06	LP200B	LP200B	LP200B	LP200B	MA534 / MA533	MA534 / MA533
TRIUMPH®	DAYTONA 675	06 - 08	LP200B	LP200B	LP200B	LP200B	MA534 / MA533	MA534 / MA533
TRIUMPH®	DAYTONA 675 /675 R	09 -	LP200B	LP200B	LP200B	LP200B	MA534 / MA533	MA534 / MA533
YAMAHA®	FZ1 FAZER	06 -	LP300B	LP300B	LP300B	LP300B	MA534 / MA533 ¹	MA534 / MA533 ¹
YAMAHA®	FZ6 FAZER	04 - 08	LP300B	LP300B	LP300B	LP300B	MA534 / MA533 ¹	MA534 / MA533 ¹
YAMAHA®	YZF-R1	00 -	Included	Included	Included	Included	MA534 / MA533 ¹	MA534 / MA533 ¹
YAMAHA®	YZF-R6	99 - 05	LP200B	LP200B	LP200B	LP200B	MA534 / MA533 ¹	MA534 / MA533 ¹
YAMAHA®	YZF-R6	06 -	Included	Included	Included	Included	MA534 / MA533 ¹	MA534 / MA533 ¹

¹ Adapter MA600 is required, see page 93.

TECHNICAL INFO BAR END MIRROR ADAPTORS

■	■	■	■	■
—	BS816B	—	—	—
—	BS755B	—	—	—
—	LP200B	—	—	—
—	LP300B	—	—	—
—	LP305B	—	—	—
—	LP310B	—	—	—
—	LP320B	—	—	—
—	LP321B	—	—	—
—	LP322B	—	—	—
—	LP323B	—	—	—
—	LP324B	—	—	—
—	LP335B	—	—	—
—	LP400B	—	—	—
MA534A	MA534B	MA534G	MA534R	MA534U
MA533A	MA533B	MA533G	MA533R	MA533U
—	MA525B	—	—	MA525U

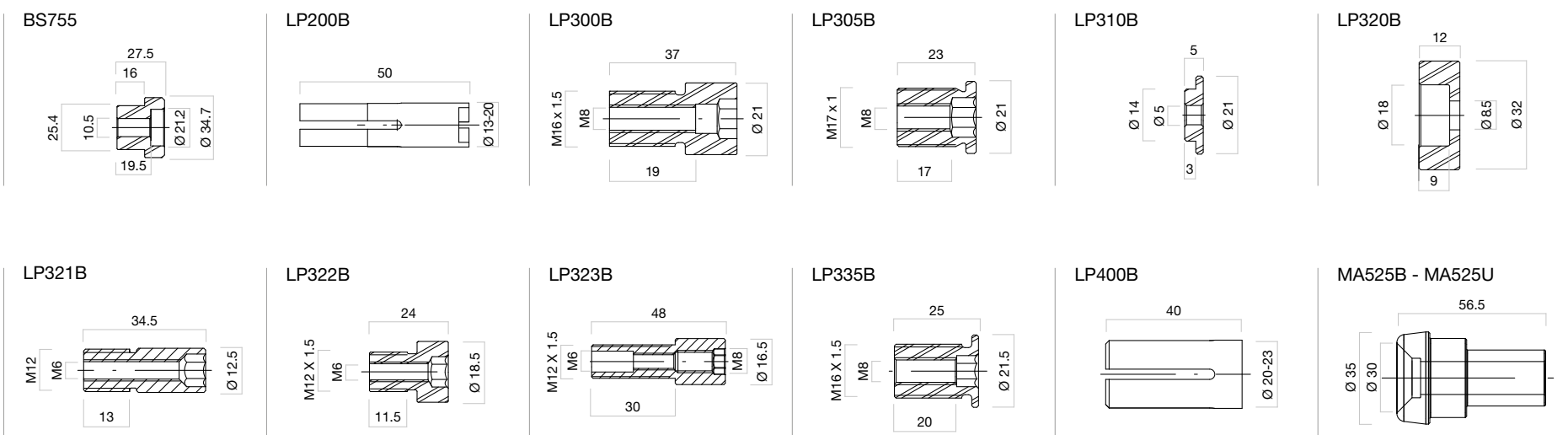

MA534 / MA533: Pictures and technical info: see page 92.

MARKER LIGHTS

ZERO



E-HOMOLOGATION | SMD LED TECHNOLOGY | MACHINED FROM BILLET ALUMINUM
HIGH INTENSITY LIGHT | GEOMETRIC DESIGN AND SMALL DIMENSION

FR035A



FR035B

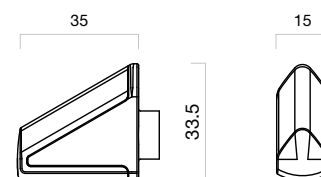

UNIVERSAL
MARKER LIGHTS
ACTION



E-HOMOLOGATION | SMD LED TECHNOLOGY | MACHINED FROM BILLET ALUMINUM
HIGH INTENSITY LIGHT | DYNAMIC DESIGN

FR028A



FR028B

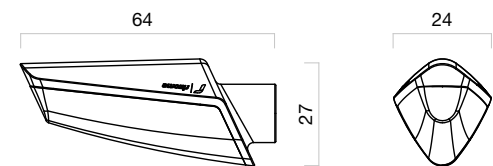

Adaptors pages 64 - 65

016NEW



UNIVERSAL
MARKER LIGHTS
SGUARDO



E-HOMOLOGATION | MULTIFUNCTION SMD LED TECHNOLOGY | MACHINED FROM BILLET ALUMINUM
HIGH INTENSITY LIGHT | USABLE WITH Ø 22 mm (7/8) AND 25,4 mm (1 INCH) HANDLEBAR | TWO COLORS AVAILABLE

■
FR060B



■
FR060CH

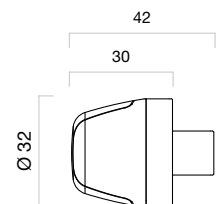

Adaptors pages 64 - 65

MARKER LIGHTS

CLUB line

CLUB | 1 Function

Intermittent
Light



CLUB S | 3 Functions

Intermittent
Light



Integrated Rear
Position Light



Stop
Light



CLUB L | 2 Functions

Intermittent
Light



Integrated Front
Position Light



E-HOMOLOGATION | MULTIFUNCTION SMD LED TECHNOLOGY | MACHINED FROM BILLET ALUMINUM
HIGH INTENSITY LIGHT | SMALL DIMENSIONS | CLASSIC STYLE

	Position	■	▬
CLUB	Front / Rear	FR150B	FR150CH
CLUB L	Front	FR151B	FR151CH
CLUB S	Rear	FR155B	FR155CH

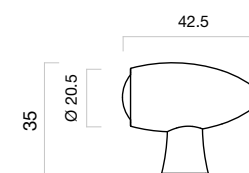



MARKER LIGHTS / ADAPTORS



The kit includes 4 pieces which are made of PVC.

Brand	Model	Year	■
BMW®	R nineT	14 -	FR221B
BMW®	F 800 R	09 - 14	FR221B
BMW®	F 800 GS ADVENTURE	13 -	FR221B
BMW®	K 1300 R	09 -	FR221B
BMW®	S 1000 R	14 -	FR221B
BMW®	S 1000 RR	09 -	FR221B
BMW®	S 1000 XR	15 -	FR221B
BMW®	R 1200 GS	13 -	FR221B
BMW®	R 1200 R / R 1200 R CLASSIC	06 - 15	FR221B
BMW®	C 600 SPORT	12 -	FR221B
BUELL®	XB12SS	08 -	FR218B
DUCATI®	MONSTER 1200 / 821	14 -	FR218B ²
DUCATI®	SCRAMBLER	15 -	FR231B
DUCATI®	MULTISTRADA 1200 / 1200 S	13 -	FR216B
DUCATI®	HYPERMOTARD SP	14 -	FR417B
DUCATI®	HYPERMOTARD / HYPERSTRADA	13 -	FR417B
DUCATI®	1299 PANIGALE / 1299 PANIGALE S	15 -	FR232B
DUCATI®	899 PANIGALE	14 -	FR216B
DUCATI®	1199 PANIGALE / 1199 PANIGALE S	12 -	FR216B
DUCATI®	STREETFIGHTER / STREETFIGHTER S	09 -	FR212B
DUCATI®	STREETFIGHTER 848	12 -	FR212B
HONDA®	CBR 600 RR / CBR 600 RR C- ABS	13 -	FR226B
HONDA®	Other models	All	FR216B
KAWASAKI®	ER-6N / ER 6F	09 - 12	FR216B
KAWASAKI®	ER-6N / ER 6F	13 -	FR415B
KAWASAKI®	NINJA 300	15 -	FR415B
KAWASAKI®	NINJA 600 ZX-6R	09 -	FR214B
KAWASAKI®	VERSYS 1000 ABS	12 -	FR415B
KAWASAKI®	Z300	15 -	FR415B
KAWASAKI®	Z750R	11 -	FR214B
KAWASAKI®	Z800	13 -	FR415B
KAWASAKI®	Z1000	14 -	FR415B
KAWASAKI®	Other models	All	FR210B
KTM®	1290 SUPER DUKE R	15 -	FR230B

Brand	Model	Year	■
MV AGUSTA®	BRUTALE DRAGSTER 800	14 -	FR416B
MV AGUSTA®	BRUTALE DRAGSTER 800	14 -	FR418B ¹
MV AGUSTA®	BRUTALE 675	12 -	FR416B
MV AGUSTA®	BRUTALE 800	13 - 15	FR416B
MV AGUSTA®	BRUTALE 920	11 -	FR212B
MV AGUSTA®	BRUTALE 1090 RR	10 -	FR212B
MV AGUSTA®	RIVALE 800	13 - 15	FR418B ¹
MV AGUSTA®	F3 675	12 -	FR216B
SUZUKI®	All	All	FR214B
TRIUMPH®	DAYTONA 675 / 675 R	09 -	FR218B
TRIUMPH®	SPEED TRIPLE 1050 / 1050 R	11 - 15	FR218B
TRIUMPH®	STREET TRIPLE RX	15 -	FR218B
TRIUMPH®	STREET TRIPLE / STREET TRIPLE R	12 -	FR218B
TRIUMPH®	TIGER 800	11 -	FR218B
TRIUMPH®	TIGER EXPLORER	12 -	FR221B
TRIUMPH®	THRUXTON	15 -	FR219B
TRIUMPH®	BONNEVILLE T100	14 -	FR219B
TRIUMPH®	SCRAMBLER 900	14 -	FR219B
YAMAHA®	MT-09 TRACER / FJ-09	15 -	FR212B
YAMAHA®	MT-09 / FZ-09	13 -	FR212B
YAMAHA®	MT-07 / FZ-07	14 -	FR212B
YAMAHA®	FZ1 FAZER	06 -	FR212B
YAMAHA®	FZ6 FAZER	04 -	FR212B
YAMAHA®	FZ8	10 -	FR212B
YAMAHA®	XV950R	15 -	FR228B ²
YAMAHA®	XV950R	15 -	FR229B ³
YAMAHA®	XJR 1300	15 -	FR227B
YAMAHA®	XJ6	09 -	FR212B
YAMAHA®	YZF-R1	02 -	FR212B
YAMAHA®	YZF-R6	03 -	FR212B
YAMAHA®	Other models	All	FR210B

¹Rizoma Marker Light adaptor for OEM License plate support.

²FR228B: Front Marker Light Adaptors.

³FR229B: Rear Marker Light Adaptors.

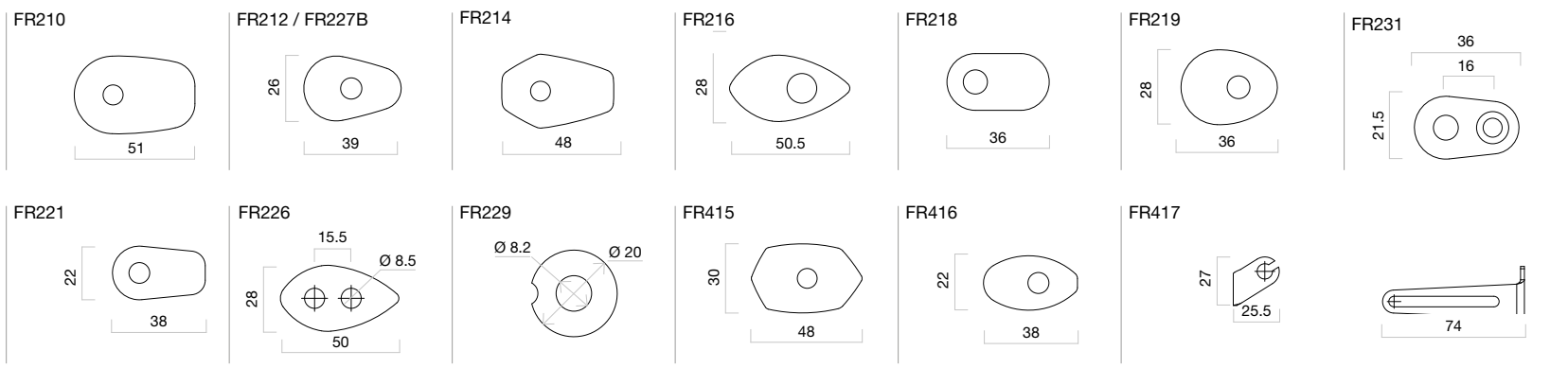

Front Marker Light Adaptors (Ø 39/41/43 mm)

■
FR228B

The kit includes 3 spacers to allow fitment to fork tubes with outside diameters of 39/41/43 mm.

MARKER LIGHTS / ADAPTORS

The cable kit is required for mounting. In the table below there are the most common bike models. In each case, before ordering, please, check the technical drawings.



Marker Light and "VELOCE L" Mirror Cable kit

Brand	Model	Year	Front	Rear
APRILIA®	All	All	EE097H	EE097H
BMW®	All	All	E0078H	EE078H
DUCATI®	1299 / 1199 / 899 PANIGALE	14 -	EE047H	EE079H
DUCATI®	Other models	All	EE079H	EE079H
HONDA®	CB 650 F	15 -	EE092H	EE075H
HONDA®	Other models	All	EE075H	EE075H
KAWASAKI®	All	All	EE074H	EE074H
KTM®	1290 SUPERDUKE R	15 -	EE047H	EE047H
MV AGUSTA®	BRUTALE DRAGSTER 800	14 -	EE073H	FR418B ¹
MV AGUSTA®	RIVALE 800	14 -	EE048H	EE047H / FR418B ¹
MV AGUSTA®	Other models	All	EE047H	EE047H
SUZUKI®	All	All	EE085H	EE085H
TRIUMPH®	All ²	All	EE082H	EE082H
YAMAHA®	XV950R	15 -	EE112H	EE088H
YAMAHA®	YZF-R1	15 -	EE116H	EE088H
YAMAHA®	MT-09 TRACER / FJ-09	13 -	EE088H	EE088H
YAMAHA®	MT-07 / FZ-07	14 -	EE088H	EE088H
YAMAHA®	XJR1300	13 -	EE088H	EE088H
YAMAHA®	Other models	All	EE093H	EE093H

¹ Rizoma Indicator Light adapter Kit for OEM License plate support (See page 247)

² Except TRIUMPH® BONNEVILLE, THRUXTON, SCRAMBLER



Electronic Signal Flasher kit

Code

EE031H

Our technicians recommend the replacement of the original (OEM) relay with our EE031 in correspondence of the mounting of Rizoma indicators when four indicators are replaced.

This will maintain the correct flash rate as the original system albeit with different Watt. Use of the EE031 eliminates the need to use individual resistors.



Marker light spacer



FR300B







STREET EDITION

RIZOMA EXCLUSIVE PATENT | LEVER PROTECTION IN CASE OF ACCIDENTAL CONTACT
AERODYNAMIC EFFICIENCY | AVAILABLE IN THREE COLORS



RACING EDITION

BRAKE LEVER PROTECTION IN CASE OF ACCIDENTAL CONTACT
AERODYNAMIC EFFICIENCY | HIGH FREEDOM OF MOVEMENT FOR THE HAND
USED BY THE BEST RACING TEAMS

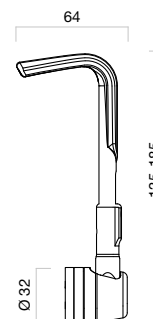

PROGUARD SYSTEM® STREET EDITION

Position	<input type="checkbox"/>	<input checked="" type="checkbox"/>	<input type="checkbox"/>
Biposition	LP010A	LP010B	LP010G



The kit is complete with 1x screw M6x40 UNI5931.
 Weight: 184 gr
 Adaptors: see page 69.

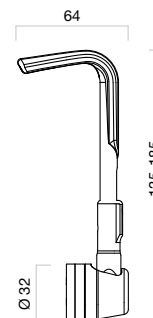

PROGUARD SYSTEM® RACING EDITION

Position	<input checked="" type="checkbox"/>
Right	LPR040B



The kit is complete with 1x screw M6x40 UNI5931, 1x screw m8x80 (Ergal®).
 Adapter for Handlebars with Ø 13mm-20mm included. Weight: 116 gr
 Adaptors for OEM handlebars: see page 69.

PROGUARD SYSTEM® ADAPTORS

The universal Adaptors are used to mount the PROGUARD on any handlebar with the inner diameter 13 -23 mm.

The specific adaptors listed below are for motorcycles that do not have a hollow bar with an ID between 13 mm and 23 mm or that have a specific mounting requirement.

Adaptors for handlebars ø 13-20 / 20-23 mm

■	Ø (mm)
LP200B	13 - 20
LP400B	20 - 23

Adaptors for OEM handlebars

Brand	Model	Year	■
APRILIA®	RSV4	09 -	LP200B
BMW®	R nineT	14 -	LP325B
BMW®	F 800 R	09 - 14	LP322B
BMW®	K 1200 R	08 - 09	LP305B
BMW®	K 1300 R	09 -	LP320B
BMW®	R 1200 GS	13 -	LP324B
BMW®	R 1200 GS ADVENTURE	14 -	LP324B
BMW®	R 1200 R	15 -	LP324B
BMW®	R 1200 R CLASSIC	15 -	LP324B
BMW®	R 1200 R	06 - 14	LP320B
BMW®	R 1200 R CLASSIC	06 - 14	LP320B
BMW®	S 1000 R	14 -	LP325B
BMW®	S 1000 RR	10 -	LP321B
BMW®	S 1000 XR ¹	15 -	LP324B
BMW®	C 600 SPORT	12 -	LP323B
BMW®	C 650 GT	12 -	LP323B
BUELL®	All	All	LP200B
DUCATI®	1299 PANIGALE	15 -	LP330B
DUCATI®	1299 PANIGALE S	15 -	LP330B
DUCATI®	899 PANIGALE	14 -	LP330B
DUCATI®	1199 PANIGALE	12 -	LP330B
DUCATI®	1199 PANIGALE S	12 -	LP330B
DUCATI®	Other models	All	LP200B
HARLEY-DAVIDSON®	All	All	LP400B
HONDA®	All	All	LP200B
KAWASAKI®	All	All	LP305B

Brand	Model	Year	■
KTM®	All	All	LP200B
MV AGUSTA®	BRUTALE 675	12 -	LP335B
MV AGUSTA®	BRUTALE 800	13 - 15	LP335B
MV AGUSTA®	RIVALE 800	13 - 15	LP335B
MV AGUSTA®	BRUTALE 750	All	LP200B
MV AGUSTA®	BRUTALE 910 / 920 / 989	All	LP200B
MV AGUSTA®	BRUTALE 1078 / 1090	All	LP200B
MV AGUSTA®	F3 675	12 -	LP200B
MV AGUSTA®	F4 750 / F4 1000	All	LP200B
SUZUKI®	All	All	LP200B
TRIUMPH®	SPEED TRIPLE 1050	11 - 15	LP310B
TRIUMPH®	SPEED TRIPLE 1050 R	11 - 15	LP310B
TRIUMPH®	STREET TRIPLE RX ²	15 -	Included
TRIUMPH®	STREET TRIPLE ²	13 -	Included
TRIUMPH®	STREET TRIPLE R ²	13 -	Included
TRIUMPH®	STREET TRIPLE	07 - 12	LP310B
TRIUMPH®	STREET TRIPLE R	07 - 12	LP310B
TRIUMPH®	Other models	All	LP200B
YAMAHA®	MT-09 TRACER / FJ-09	15 -	LP335B
YAMAHA®	YZF-R6	06 -	Included
YAMAHA®	YZF-R6	99 - 05	LP200B
YAMAHA®	YZF-R1	98 -	Included
YAMAHA®	Other models	All	LP300B

¹ Do not fit with the original hand-protectors.

² TRIUMPH® STREET TRIPLE / STREET TRIPLE R - YEAR 2013: PROGUARD SYSTEM® Right side only - adapter included.

Handlebar Cap

■
MA301B

Bar end Finisher left side PROGUARD SYSTEM®.



016NEW



UNIVERSAL BRAKE / CLUTCH LEVERS



3D

MACHINED FROM BILLET ALUMINUM | 3D MACHINING | LIGHT WEIGHT AND AERODYNAMIC
EXTREME GRIP AND WIDE ADJUSTMENT | ARTICULATED JOINT TO MINIMIZE CHANCE OF BREAKAGE
INTERCHANGEABLE COLORED RING KIT



BRAKE / CLUTCH LEVERS “3D”
HONDA®

Model	Year	Brake Lever		
		■	■	■
CB 1000 R	08 -	LBJ103A	LBJ103B	LBJ103G
CBR 600 RR / CBR 600 RR C- ABS	07 -	LBJ104A	LBJ104B	LBJ104G
CBR 600 RR / CBR 600 RR C- ABS	07 -	LBJ104A	LBJ104B	LBJ104G
CBR 1000 RR	04 - 07	LBJ103A	LBJ103B	LBJ103G
CBR 1000 RR // CBR 1000 RR C- ABS	08 -	LBJ104A	LBJ104B	LBJ104G
CBR 1000 RR // CBR 1000 RR C- ABS	08 -	LBJ104A	LBJ104B	LBJ104G

KAWASAKI®

Model	Year	Brake Lever		
		■	■	■
NINJA 600 ZX-6R	07 - 12	LBJ301A	LBJ301B	LBJ301G
NINJA 1000 ZX-10R	06 -	LBJ301A	LBJ301B	LBJ301G
Z750R	10 -	LBJ301A	LBJ301B	LBJ301G
Z750R	10 -	LBJ301A	LBJ301B	LBJ301G
Z750	07 -	LBJ302A	LBJ302B	LBJ302G
Z750	07 -	LBJ302A	LBJ302B	LBJ302G
Z800 / Z800 ABS	13 -	LBJ302A	LBJ302B	LBJ302G
Z800 / Z800 ABS	13 -	LBJ302A	LBJ302B	LBJ302G
Z1000 / Z1000SX	07 -	LBJ301A	LBJ301B	LBJ301G
Z1000 / Z1000SX	07 -	LBJ301A	LBJ301B	LBJ301G

KTM®

Model	Year	Brake Lever		
		■	■	■
1290 SUPER DUKE R	15 -	LBJ500A	LBJ500B	LBJ500G
1290 SUPER DUKE R	15 -	LBK500A ¹	LBK500B ¹	LBK500G ¹

MV AGUSTA®

Model	Year	Brake Lever		
		■	■	■
F3 675	12 -	LBJ400A	LBJ400B	LBJ400G

SUZUKI®

Model	Year	Brake Lever		
		■	■	■
GSX R 600	06 -	LBJ400A	LBJ400B	LBJ400G
GSX R 600	06 -	LBJ400A	LBJ400B	LBJ400G
GSX R 750	06 -	LBJ400A	LBJ400B	LBJ400G
GSX R 750	06 -	LBJ400A	LBJ400B	LBJ400G
GSX R 1000	05 - 06	LBJ400A	LBJ400B	LBJ400G
GSX R 1000	05 - 06	LBJ400A	LBJ400B	LBJ400G

¹LBK500 comes complete with Remote Adjuster.

Clutch Lever

	■	■	■	Reg.
LCJ200A	LCJ200B	LCJ200G	—	
LCJ201A	LCJ201B	LCJ201G	✓	
LC1J01A	LC1J01B	LC1J01G	✓	
LCJ200A	LCJ200B	LCJ200G	—	
LCJ201A	LCJ201B	LCJ201G	✓	

Clutch Lever

	■	■	■	Reg.
LCJ301A	LCJ301B	LCJ301G	—	
LCJ301A	LCJ301B	LCJ301G	—	
LCJ302A	LCJ302B	LCJ302G	✓	
LCJ301A	LCJ301B	LCJ301G	—	
LCJ302A	LCJ302B	LCJ302G	✓	
LCJ301A	LCJ301B	LCJ301G	—	
LCJ302A	LCJ302B	LCJ302G	✓	
LCJ301A	LCJ301B	LCJ301G	—	
LCJ302A	LCJ302B	LCJ302G	✓	

Clutch Lever

	■	■	■	Reg.
LCJ676A	LCJ676B	LCJ676G	✓	

Clutch Lever

	■	■	■	Reg.

Clutch Lever

	■	■	■	Reg.
LCJ201A	LCJ201B	LCJ201G	✓	
LCJ200A	LCJ200B	LCJ200G	—	
LCJ201A	LCJ201B	LCJ201G	✓	
LCJ200A	LCJ200B	LCJ200G	—	
LCJ201A	LCJ201B	LCJ201G	✓	



BRAKE / CLUTCH LEVERS “3D”
TRIUMPH®

Model	Year	Brake Lever		
		■	■	■
SCRAMBLER	14 -	LBJ100A	LBJ100B	LBJ100G
BONNEVILLE T100	08 -	LBJ100A	LBJ100B	LBJ100G
THRUXTON	15 -	LBJ100A	LBJ100B	LBJ100G
DAYTONA 675	06 -	LBJ400A	LBJ400B	LBJ400G
DAYTONA 675 R	11 -	LBJ500A	LBJ500B	LBJ500G
SPEED TRIPLE 1050 / 1050 R	11 - 15	LBJ500A	LBJ500B	LBJ500G
SPEED TRIPLE 1050	08 - 10	LBJ400A	LBJ400B	LBJ400G
STREET TRIPLE RX	15 -	LBJ400A	LBJ400B	LBJ400G
STREET TRIPLE R	09 -	LBJ400A	LBJ400B	LBJ400G

Clutch Lever			Reg.
■	■	■	
LCJ801A	LCJ801B	LCJ801G	✓
LCJ801A	LCJ801B	LCJ801G	✓
LCJ801A	LCJ801B	LCJ801G	✓
LCJ801A	LCJ801B	LCJ801G	✓
LCJ801A	LCJ801B	LCJ801G	✓
LCJ801A	LCJ801B	LCJ801G	✓
LCJ801A	LCJ801B	LCJ801G	✓
LCJ801A	LCJ801B	LCJ801G	✓

YAMAHA®

Model	Year	Brake Lever		
		■	■	■
MT-09 TRACER / FJ-09	15 -	LBJ205A	LBJ205B	LBJ205G
MT-09 TRACER / FJ-09	15 -	LBJ205A	LBJ205B	LBJ205G
MT-07 / FZ-07	14 -	LBJ205A	LBJ205B	LBJ205G
MT-07 / FZ-07	14 -	LBJ205A	LBJ205B	LBJ205G
MT-09 / FZ-09	13 -	LBJ205A	LBJ205B	LBJ205G
MT-09 / FZ-09	13 -	LBJ205A	LBJ205B	LBJ205G
FZ1 / FZ1 FAZER	06 -	LBJ200A	LBJ200B	LBJ200G
FZ1 / FZ1 FAZER	06 -	LBJ200A	LBJ200B	LBJ200G
FZ6 / FZ6 FAZER	04 -	LBJ200A	LBJ200B	LBJ200G
FZ6 / FZ6 FAZER	04 -	LBJ200A	LBJ200B	LBJ200G
FZ8	10 -	LBJ205A	LBJ205B	LBJ205G
FZ8	10 -	LBJ205A	LBJ205B	LBJ205G
T-MAX 500 / T-MAX 530	08 -	LBJ202A ¹	LBJ202B ¹	LBJ202G ¹
T-MAX 500 / T-MAX 530	08 -	LBJ205A ¹	LBJ205B ¹	LBJ205G ¹
XJR 1300	15 -	LBJ205A	LBJ205B	LBJ205G
XJ6	08 -	LBJ200A	LBJ200B	LBJ200G
XJ6	08 -	LBJ200A	LBJ200B	LBJ200G
YZF-R1	15 -	LBJ210A ²	LBJ210B ²	LBJ210G ²
YZF-R1	07 - 08	LBJ201A	LBJ201B	LBJ201G
YZF-R1	07 - 08	LBJ201A	LBJ201B	LBJ201G
YZF-R6	06 -	LBJ201A	LBJ201B	LBJ201G
YZF-R6	06 -	LBJ201A	LBJ201B	LBJ201G

Clutch Lever			Reg.
■	■	■	
LCJ200A	LCJ200B	LCJ200G	—
LCJ201A	LCJ201B	LCJ201G	✓
LCJ200A	LCJ200B	LCJ200G	—
LCJ201A	LCJ201B	LCJ201G	✓
LCJ200A	LCJ200B	LCJ200G	—
LCJ201A	LCJ201B	LCJ201G	✓
LCJ200A	LCJ200B	LCJ200G	—
LCJ201A	LCJ201B	LCJ201G	✓
LCJ200A	LCJ200B	LCJ200G	—
LCJ201A	LCJ201B	LCJ201G	✓
—	—	—	—
—	—	—	—
LCJ802A	LCJ802B	LCJ802G	✓
LCJ200A	LCJ200B	LCJ200G	—
LCJ201A	LCJ201B	LCJ201G	✓
LCJ210A	LCJ210B	LCJ210G	✓
LCJ200A	LCJ200B	LCJ200G	—
LCJ201A	LCJ201B	LCJ201G	✓
LCJ200A	LCJ200B	LCJ200G	—
LCJ201A	LCJ201B	LCJ201G	✓

¹ LBJ202: Rear brake - LBJ205: Front brake

² LBJ210 is compatible with the Rizoma RM004 Remote Adjuster sold separately in three colors. (See page 279)

Remote Adjuster

■	■	■
RM005B	RM005R	RM005RU





UNIVERSAL
BRAKE / CLUTCH LEVERS



RRC
MACHINED FROM BILLET ALUMINUM | 3D MACHINING
UP TO SIX ADJUSTMENT POSITIONS | LIGHT WEIGHT AND AERODYNAMIC | SPORTY DESIGN

BRAKE / CLUTCH LEVERS "RRC"

APRILIA®

Model	Year	Brake Lever		
		■	■	■
RSV4	09 -	LBR500A	LBR500B	LBR500G

Clutch Lever			Reg.
■	■	■	
LCR201A	LCR201B	LCR201G	✓

BMW®

Model	Year	Brake Lever		
		■	■	■
S 1000 R	14 -	LBR400A	LBR400B	LBR400G
S 1000 RR	09 -	LBR400A	LBR400B	LBR400G
S 1000 XR	15 -	LBR706A	LBR706B	LBR706G
C 600 SPORT / C 650 GT	12 -	LBR401A ¹	LBR401B ¹	LBR401G ¹
C 600 SPORT / C 650 GT	12 -	LBR402A ¹	LBR402B ¹	LBR402G ¹

Clutch Lever			Reg.
■	■	■	
LCR702A	LCR702B	LCR702G	✓
LCR702A	LCR702B	LCR702G	✓
LCR706A	LCR706B	LCR706G	✓
-	-	-	-
-	-	-	-

DUCATI®

Model	Year	Brake Lever		
		■	■	■
749	03 - 07	LBR500A	LBR500B	LBR500G
848	07 -	LBR500A	LBR500B	LBR500G
999	02 - 06	LBR500A	LBR500B	LBR500G
1098 / 1098 S	07 - 09	LBR500A	LBR500B	LBR500G
1198 / 1198 S	09 - 11	LBR500A	LBR500B	LBR500G
1299 PANIGALE / 1299 PANIGALE S	15 -	LBR500A	LBR500B	LBR500G
899 PANIGALE	14 -	LBR500A	LBR500B	LBR500G
1199 PANIGALE / 1199 PANIGALE S	12 -	LBR500A	LBR500B	LBR500G
DIAVEL	10 -	LBR500A	LBR500B	LBR500G
HYPERMOTARD SP	14 -	LBR211A ²	LBR211B ²	LBR211G ²
HYPERMOTARD / HYPERSTRADA	13 -	LBR503A	LBR503B	LBR503G
HYPERMOTARD 1100 / HYPERMOTARD 1100 S	07 - 09	LBR211A ²	LBR211B ²	LBR211G ²
HYPERMOTARD 1100 EVO / 1100 EVO SP	10 - 12	LBR211A ²	LBR211B ²	LBR211G ²
SCRAMBLER	15 -	LBR503A	LBR503B	LBR503G
MONSTER 821	14 -	LBR503A	LBR503B	LBR503G
MONSTER 1100 EVO	11 -	LBR500A	LBR500B	LBR500G
MONSTER 1100 / MONSTER 1100 S	09 -	LBR500A	LBR500B	LBR500G
MONSTER 1200	14 -	LBR500A	LBR500B	LBR500G
MONSTER S4 R	07 - 08	LBR500A	LBR500B	LBR500G
MONSTER S4RS TESTASTRETTA	06 - 08	LBR500A	LBR500B	LBR500G
848 / 1098 / 1198	09 -	LBR500A	LBR500B	LBR500G
STREETFIGHTER / STREETFIGHTER S	09 -	LBR500A	LBR500B	LBR500G
STREETFIGHTER 848	12 -	LBR500A	LBR500B	LBR500G

Clutch Lever			Reg.
■	■	■	
LCR500A	LCR500B	LCR500G	✓
LCR500A	LCR500B	LCR500G	✓
LCR500A	LCR500B	LCR500G	✓
LCR500A	LCR500B	LCR500G	✓
LCR500A	LCR500B	LCR500G	✓
LCR500A	LCR500B	LCR500G	✓
LCR500A	LCR500B	LCR500G	✓
LCR500A	LCR500B	LCR500G	✓
LCR500A	LCR500B	LCR500G	✓
LCR500A	LCR500B	LCR500G	✓
LCR503A ²	LCR503B ²	LCR503G ²	✓
LCR503A	LCR503B	LCR503G	✓
LCR500A ²	LCR500B ²	LCR500G ²	✓
LCR500A ²	LCR500B ²	LCR500G ²	✓
LCR503A	LCR503B	LCR503G	✓
LCR503A	LCR503B	LCR503G	✓
LCR500A	LCR500B	LCR500G	✓
LCR500A	LCR500B	LCR500G	✓
LCR500A	LCR500B	LCR500G	✓
LCR500A	LCR500B	LCR500G	✓
LCR500A	LCR500B	LCR500G	✓
LCR500A	LCR500B	LCR500G	✓
LCR500A	LCR500B	LCR500G	✓

HONDA®

Model	Year	Brake Lever		
		■	■	■
CB 650 F	15 -	LBR100A	LBR100B	LBR100G
CBR 600 F	10 -	LBR100A	LBR100B	LBR100G
CBR 600 RR / CBR 600 RR C- ABS	07 -	LBR104A	LBR104B	LBR104G
CBR 1000 RR	08 -	LBR104A	LBR104B	LBR104G
HORNET 600 / HORNET 600 ABS	07 -	LBR100A	LBR100B	LBR100G
INTEGRA	12 -	LBR100A ¹	LBR100B ¹	LBR100G ¹
INTEGRA	12 -	LBR105A ¹	LBR105B ¹	LBR105G ¹

Clutch Lever			Reg.
■	■	■	
LCR102A	LCR102B	LCR102G	✓
LCR201A	LCR201B	LCR201G	✓
LCR201A	LCR201B	LCR201G	✓
LCR201A	LCR201B	LCR201G	✓
LCR201A	LCR201B	LCR201G	✓
-	-	-	-
-	-	-	-

¹LBR105 / LBR402: front brake - LBR100 / LBR401: rear brake.

²Do not fit with the original hand-protectors.



BRAKE / CLUTCH LEVERS "RRC"
KAWASAKI®

Model	Year	Brake Lever		
		■	■	■
VERSYS 1000 ABS	12 -	LBR100A	LBR100B	LBR100G
Z750R	10 -	LBR301A	LBR301B	LBR301G
Z750	07 -	LBR302A	LBR302B	LBR302G
Z800 / Z800 ABS	13 -	LBR302A	LBR302B	LBR302G
Z1000 / Z1000SX	07 -	LBR301A	LBR301B	LBR301G
NINJA 600 ZX-6R	05 -	LBR301A	LBR301B	LBR301G
NINJA 636 ZX-6R	13 -	LBR301A	LBR301B	LBR301G
NINJA 636 ZX-6R	05 - 06	LBR400A	LBR400B	LBR400G
NINJA 1000 ZX-10R	06 -	LBR301A	LBR301B	LBR301G

Clutch Lever			Reg.
■	■	■	
LCR301A	LCR301B	LCR301G	✓
LCR301A	LCR301B	LCR301G	✓
LCR301A	LCR301B	LCR301G	✓
LCR301A	LCR301B	LCR301G	✓
LCR301A	LCR301B	LCR301G	✓
LCR301A	LCR301B	LCR301G	✓
LCR301A	LCR301B	LCR301G	✓
LCR301A	LCR301B	LCR301G	✓

MV AGUSTA®

Model	Year	Brake Lever		
		■	■	■
F3 675	12 -	LBR400A	LBR400B	LBR400G
BRUTALE DRAGSTER 800	14 -	LBR601A	LBR601B	LBR601G
BRUTALE 675	12 -	LBR601A	LBR601B	LBR601G
BRUTALE 800 / RIVALE 800	13 - 15	LBR601A	LBR601B	LBR601G

Clutch Lever			Reg.
■	■	■	
LCR601A	LCR601B	LCR601G	✓
LCR601A	LCR601B	LCR601G	✓
LCR601A	LCR601B	LCR601G	✓
LCR601A	LCR601B	LCR601G	✓

SUZUKI®

Model	Year	Brake Lever		
		■	■	■
GSX R 600	06 -	LBR400A	LBR400B	LBR400G
GSX R 750	06 -	LBR400A	LBR400B	LBR400G
GSX R 1000	09 -	LBR400A	LBR400B	LBR400G

Clutch Lever			Reg.
■	■	■	
LCR201A	LCR201B	LCR201G	✓
LCR201A	LCR201B	LCR201G	✓
LCR201A	LCR201B	LCR201G	✓

TRIUMPH®

Model	Year	Brake Lever		
		■	■	■
DAYTONA 675	09 -	LBR400A	LBR400B	LBR400G
DAYTONA 675 R	11 -	LBR500A	LBR500B	LBR500G
SPEED TRIPLE 1050 / 1050 R	11 - 15	LBR500A	LBR500B	LBR500G
SPEED TRIPLE 1050	08 - 10	LBR400A	LBR400B	LBR400G
SPEED TRIPLE 1050	05 - 07	LBR100A	LBR100B	LBR100G
STREET TRIPLE	07 -	LBR100A	LBR100B	LBR100G
STREET TRIPLE RX	15 -	LBR400A	LBR400B	LBR400G
STREET TRIPLE R	09 -	LBR400A	LBR400B	LBR400G
TIGER 800	11 -	LBR100A	LBR100B	LBR100G
SCRAMBLER 900	14 -	LBR100A	LBR100B	LBR100G
THRUXTON	15 -	LBR100A	LBR100B	LBR100G
BONNEVILLE T100	08 -	LBR100A	LBR100B	LBR100G

Clutch Lever			Reg.
■	■	■	
LCR801A	LCR801B	LCR801G	✓
LCR801A	LCR801B	LCR801G	✓
LCR801A	LCR801B	LCR801G	✓
LCR801A	LCR801B	LCR801G	✓
LCR801A	LCR801B	LCR801G	✓
LCR801A	LCR801B	LCR801G	✓
LCR801A	LCR801B	LCR801G	✓
LCR801A	LCR801B	LCR801G	✓
LCR801A	LCR801B	LCR801G	✓

YAMAHA®

Model	Year	Brake Lever		
		■	■	■
MT-09 TRACER / FJ-09	15 -	LBR205A	LBR205B	LBR205G
MT-07 / FZ-07	14 -	LBR205A	LBR205B	LBR205G
MT-09 / FZ-09	13 -	LBR205A	LBR205B	LBR205G
YZF-R6	06 -	LBR211A	LBR211B	LBR211G
YZF-R1	15 -	LBR210A	LBR210B	LBR210G
YZF-R1	09 - 14	LBR206A	LBR206B	LBR206G

Clutch Lever			Reg.
■	■	■	
LCR201A	LCR201B	LCR201G	✓
LCR201A	LCR201B	LCR201G	✓
LCR201A	LCR201B	LCR201G	✓
LCR201A	LCR201B	LCR201G	✓
LCR201A	LCR201B	LCR201G	✓
LCR201A	LCR201B	LCR201G	✓





MACHINED FROM BILLET ALUMINUM | ERGONOMIC SHAPE AND MAXIMUM GRIP
INTERCHANGEABLE COLORED ALUMINUM RING KIT | TWO COLORS AVAILABLE

Ø	■	■
22 mm	GR221A	GR221B
		

Adaptors for all bike models included except for:

Brand	Model	Year	■
APRILIA®	RSV4	09 - 10	GR418B
BMW®	K 1200 R	05 - 08	GR416B
BMW®	R 1200 S	06 - 09	GR416B
BMW®	R 1200 R	06 - 09	GR416B
BMW®	R 1200 GS	04 - 07	GR416B
KTM®	RC8	08 -	GR418B
MV AGUSTA®	BRUTALE	All	GR414B
MV AGUSTA®	F4	99 - 12	GR414B

Gold, Black and Red Rings included.

Not compatible with Ride By Wire.

Not compatible with Electronic Power Management System.



UNIVERSAL

GRIPS

URLO 25.4



MACHINED FROM BILLET ALUMINUM | ERGONOMIC SHAPE AND MAXIMUM GRIP
AVAILABLE IN TWO COLORS | REMOVABLE ENDCAP

Ø	Brand	■	■
25.4 mm (1 Inch)	HARLEY-DAVIDSON®	GR231B	—
25.4 mm (1 Inch)	HARLEY-DAVIDSON®	—	GR231CH
25.4 mm (1 Inch)	TRIUMPH®	GR236B	—
25.4 mm (1 Inch)	TRIUMPH®	—	GR236CH



Adaptors included.
Not compatible with Ride By Wire. Not compatible with Electronic
Power Management System.



UNIVERSAL GRIPS LEGEND



MACHINED FROM BILLET ALUMINUM | COMFORT AND GRIP
CLASSIC SOUL | AVAILABLE WITH 22mm (7/8) AND 25,4 mm (1 INCH) DIAMETER

Ø	Brand	■	■	■
22 mm	All	GR220A	GR220B	—
25.4 mm (1 Inch)	HARLEY-DAVIDSON®	—	GR230B	—
25.4 mm (1 Inch)	HARLEY-DAVIDSON®	—	—	GR230CH
25.4 mm (1 Inch)	TRIUMPH®	—	GR235B	—
25.4 mm (1 Inch)	TRIUMPH®	—	—	GR235CH



Adaptors for all bike models included in Kit it GR220A / GR220B except for:

Brand	Model	Year	■
APRILIA®	RSV4	09 - 10	GR418B
BMW®	K 1200 R	05 - 08	GR416B
BMW®	R 1200 S	06 - 09	GR416B
BMW®	R 1200 R	06 - 09	GR416B
BMW®	R 1200 GS	04 - 07	GR416B
KTM®	RC8	08 -	GR418B
MV AGUSTA®	BRUTALE	All	GR414B
MV AGUSTA®	F4	99 - 12	GR414B





Not compatible with Ride By Wire. Not compatible with Electronic Power Management System.



UNIVERSAL
GRIPS
SPORT



MACHINED FROM BILLET ALUMINUM | RACING RUBBER FOR HIGH GRIP
SPORTY AND EFFICIENT | FIVE COLORS AVAILABLE

Ø	■	■	■	■	■
22 mm	GR205A	GR205B	GR205G	GR205R	GR205U
					

Adaptors for all bike models included except for:

Brand	Model	Year	■
APRILIA®	RSV4	09 - 10	GR418B
BMW®	K 1200 R	05 - 08	GR416B
BMW®	R 1200 S	06 - 09	GR416B
BMW®	R 1200 R	06 - 09	GR416B
BMW®	R 1200 GS	04 - 07	GR416B
KTM®	RC8	08 -	GR418B
MV AGUSTA®	BRUTALE	All	GR414B
MV AGUSTA®	F4	99 - 12	GR414B

Not compatible with Ride By Wire. Not compatible with Electronic Power Management System.



UNIVERSAL

GRIPS

SPORT 25.4



MACHINED FROM BILLET ALUMINUM | RACING RUBBER FOR HIGH GRIP
AVAILABLE ANODIZED BLACK AND CHROME | REMOVABLE ENDCAP

Ø	Brand	■	■
25.4 mm (1 Inch)	HARLEY-DAVIDSON®	GR232B	—
25.4 mm (1 Inch)	HARLEY-DAVIDSON®	—	GR232CH
25.4 mm (1 Inch)	TRIUMPH®	GR233B	—
25.4 mm (1 Inch)	TRIUMPH®	—	GR233CH











Adaptors included.

Not compatible with Ride By Wire. Not compatible with Electronic Power Management System.



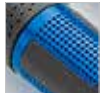

Ø					
22 mm	GR213A	GR213B	GR213G	GR213R	GR213U
					

MACHINED FROM BILLET ALUMINUM | GRIP AND COMFORT
STYLE AND EFFICIENCY | FIVE COLORS AVAILABLE

Adaptors for all bike models included except for:

Brand	Model	Year	
APRILIA®	RSV4	09 - 10	GR418B
BMW®	K 1200 R	05 - 08	GR416B
BMW®	R 1200 S	06 - 09	GR416B
BMW®	R 1200 R	06 - 09	GR416B
BMW®	R 1200 GS	04 - 07	GR416B
KTM®	RC8	08 -	GR418B
MV AGUSTA®	BRUTALE	All	GR414B
MV AGUSTA®	F4	99 - 12	GR414B

Not compatible with Ride By Wire. Not compatible with Electronic Power Management System.

HANDLEBAR CAPS



MA302A	MA302B	MA302G	MA302R	MA302U



MA532A	MA532B	MA532G	MA532R	MA532U



MA533A	MA533B	MA533G	MA533R	MA533U



MA534A	MA534B	MA534G	MA534R	MA534U



MA531A	MA531B	MA531G	MA531R	MA531U

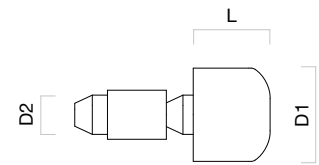

Code	D1 (mm)	D2 (mm)	L (mm)	W (gr)
MA302	32	13 - 18	32	83
MA532	32	13 - 18	28	64
MA533	28.5	13 - 18	22	44
MA534	28.5	13 - 18	20	50
MA531	31.5	13 - 18	34	34
MA530	22	13 - 18	19	41

HANDLEBAR CAPS
SWITCH



■	■
MA530A	MA530B

Adaptors for OEM handlebars

Adaptors for all bike models included except for:

Brand	Model	Year	■
BMW®	R nineT	14 -	LP321B
BMW®	F 800 R	09 - 14	LP322B
BMW®	R 1200 R	15 -	LP324B
BMW®	R 1200 GS ¹	13 -	LP324B
BMW®	S 1000 R	14 -	LP321B
BMW®	S 1000 RR	09 -	LP321B
BMW®	C 600 SPORT / C 650 GT	12 -	LP323B
TRIUMPH®	BONNEVILLE T100 ²	08 -	BS816B
YAMAHA®	FZ1 FAZER - FZ1	06 -	MA600B
YAMAHA®	FZ6 - FZ6 FAZER - MT-01	04 -	MA600B
YAMAHA®	FZS 1000 FAZER	00 - 05	MA600B
YAMAHA®	T-MAX 500 / T-MAX 530	04 -	MA600B
YAMAHA®	XJR 1300	14 -	MA600B
YAMAHA®	XJ6	08 -	MA600B
YAMAHA®	MT-09 / FZ-09	13 -	MA600B

¹ Do not fit with the original hand-protectors.

² Warning: not compatible with MA531.

HANDLEBARS

MACHINED FROM BILLET ALUMINUM | PERFORMANCE AND RELIABILITY
WIDE RANGE FOR ANY NEED AND RIDING STYLE | WIDE COLOR RANGE



UNIVERSAL HANDLEBARS



Handlebar Ø 22

					L1 (mm)	L2 (mm)	Ø D1 (mm)	Ø D2 (mm)	H (mm)	Weight (kg)	β
MA001A	MA001B	MA001G	MA001R	MA001U	720	135	22	22	45	0,50	23° +/-1°

β = Adjustment control

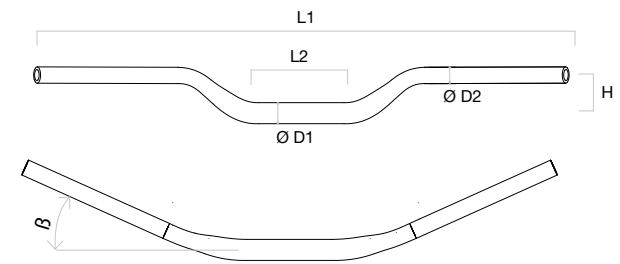

1-1/8 inch Diameter Tapered Handlebar

					L1 (mm)	L2 (mm)	Ø D1 (mm)	Ø D2 (mm)	H (mm)	Weight (kg)	β
MA006A	MA006B	MA006G	MA006R	MA006U	740	138	29	22	30	0,56	23° +/-1°
MA009A	MA009B	MA009G	MA009R	MA009U	740	138	29	22	50	0,58	23.5° +/-1°
MA011A	MA011B	MA011G	MA011R	MA011U	755	110	29	22	15	0,52	20° +/-1°

β = Adjustment control

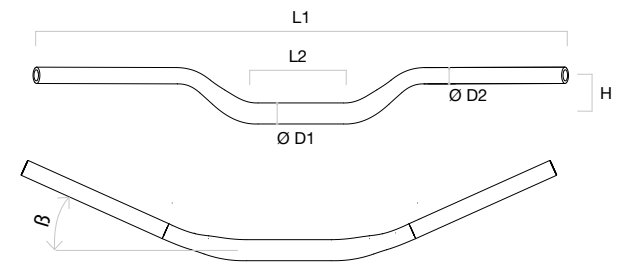

Drag bar

					L1 (mm)	L2 (mm)	Ø D1 (mm)	Ø D2 (mm)	β	Weight (kg)
MA015A	MA015B	MA015G	MA015R	MA015U	755	125	29	22	10°	0,52

β = Adjustment control

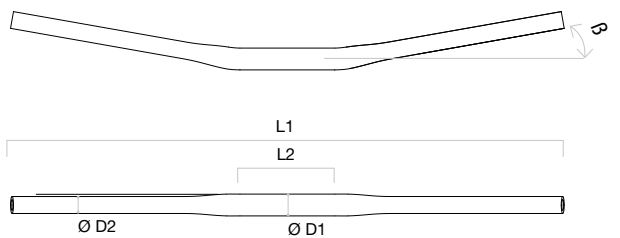





Crossbar



MA108B

Attention, the crossbar is only compatible with Rizoma MA009 tapered bars.

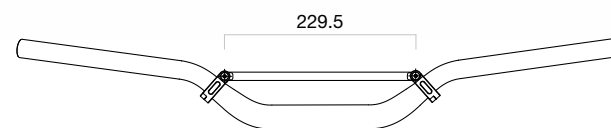





1-1/8 inch diameter handlebar risers

■	H (mm)	Ø (mm)
AZ402B	42	29
AZ403B	60	29

Screws included.

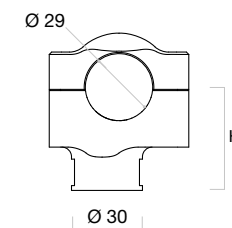

Riser adjustment kit for tapered handlebar

Brand	Model	Year	■	H (mm)	Ø (mm)
BMW®	R 850 R / R 1150 R	All	AZ405B	24	29
DUCATI®	MONSTER ¹	93 - 08	AZ405B	24	29
DUCATI®	MULTISTRADA 620	05 - 07	AZ405B	24	29
HONDA®	CB 650 F	15 -	AZ405B	24	29
HONDA®	CB 1000 R	08 - 10	AZ405B	24	29
HONDA®	HORNET 600 / 900	All	AZ405B	24	29
KAWASAKI®	ER-6F / ER-6N	06 - 08	AZ405B	24	29
SUZUKI®	GSR 600	06 -	AZ405B	24	29
YAMAHA®	FZ6 / FZ6 FAZER	04 -	AZ405B	24	29

¹ Except Monster 696 - 796 - 821 - 1100 - S4

Screws included.

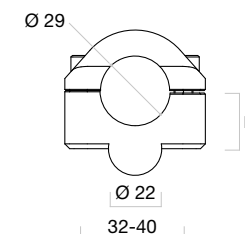

This kit allows for the mounting of 1-1/8 inch (29 mm) tapered bars to motorcycles that come with a 7/8 inch (22 mm) bar clamp integrated into the top triple clamp.



Handlebar riser Ø 25.4 mm (1 Inch)

■	H (mm)	Ø (mm)
AZ430B	42	25.4

Screws included.

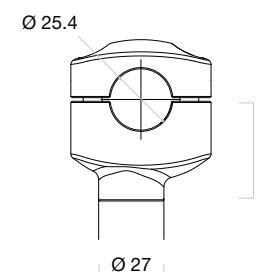



UNIVERSAL FLUID TANKS WAVE

MACHINED FROM BILLET ALUMINUM | DIFFERENT SIZES FOR DIFFERENT APPLICATIONS
FUNCTIONAL AND AESTHETIC SITE GLASS | FIVE COLORS AVAILABLE



■	■	■	■	■
CT137A	CT137B	CT137G	CT137R	CT137U

Volume: 31 cm³ - Height: 53 mm - Ø 51.5 mm

Suggested use: front brake master cylinder

Use with oil DOT 3 or DOT 4

The kit includes 3 hose nipples:

1pc. Ø 7 mm 90 degree + 1pc. Ø 8 mm 90 degree + 1pc. Ø 8 mm straight



■	■	■	■	■
CT135A	CT135B	CT135G	CT135R	CT135U

Volume: 16 cm³ - Height: 50 mm - Ø 42 mm

Suggested use: clutch master cylinder

Use with oil DOT 3 or DOT 4

The kit includes 3 hose nipples:

1pc. Ø 7 mm 90 degree + 1pc. Ø 8 mm 90 degree + 1pc. Ø 8 mm straight

To mount the fluid tanks Adaptors are required (See page 105)



For DUCATI® PANIGALE see at page 210

For HONDA® CB 1000 R see at page 218

For KAWASAKI® Z1000 see at page 228





CT027A	CT027B	CT027G	CT027R	CT027U

Volume: 25 cm³ - Height: 46 mm - Ø: 50 mm
Suggested use: front brake master cylinder
Use with oil DOT 3 or DOT 4
The kit includes a 7 mm and a 8 mm hose nipple



CT025A	CT025B	CT025G	CT025R	CT025U

Volume: 15 cm³ - Height: 49 mm - Ø: 40 mm
Suggested use: clutch master cylinder
Use with oil DOT 3 or DOT 4
The kit includes a 7 mm hose nipple



CT017A	CT017B	CT017G	CT017R	CT017U

Volume: 15 cm³ - Height: 49 mm - Ø: 40 mm
Suggested use: clutch master cylinder
Use with oil DOT 3 or DOT 4
The kit includes a 7 mm hose nipple



CT015A	CT015B	CT015G	CT015R	CT015U

Volume: 12 cm³ - Height: 42 mm - Ø: 31 mm
Suggested use: rear brake master cylinder
Use with oil DOT 3 or DOT 4
The kit includes a 8 mm hose nipple



rizoma

MADE IN ITALY
MADE IN ITALY
MADE IN ITALY

MAX

MIN

UNIVERSAL FLUID TANKS NEXT



ABE 61297 **R** 1942632

CT127A	CT127B	CT127G	CT127R	CT127U
--------	--------	--------	--------	--------

Volume: 27 cm³ - Height: 51.5 mm - Ø min: 40 mm / Ø max 65 mm

Suggested use: front brake master cylinder

Use with oil DOT 3 or DOT 4

The kit includes 3 hose nipples:

1pc. Ø 7 mm 90 degree + 1pc. Ø 8 mm 90 degree + 1pc. Ø 8 mm straight

To mount the fluid tanks Adaptors are required.



ABE 61297 **R** 1942632

CT125A	CT125B	CT125G	CT125R	CT125U
--------	--------	--------	--------	--------

Volume: 17 cm³ - Height: 43 mm - Ø min: 36 mm / Ø max 60 mm

Suggested use: clutch master cylinder

Use with oil DOT 3 or DOT 4

The kit includes 3 hose nipples:

1pc. Ø 7 mm 90 degree + 1pc. Ø 8 mm 90 degree + 1pc. Ø 8 mm straight

To mount the fluid tanks Adaptors are required.



R 1942632

CT115A	CT115B	CT115G	CT115R	CT115U
--------	--------	--------	--------	--------

Volume: 12 cm³ - Height: 42 mm - Ø min: 29 mm / Ø max 48 mm

Suggested use: rear brake master cylinder

Use with oil DOT 3 or DOT 4

The kit includes an 8 mm straight hose nipple

To mount the fluid tanks Adaptors are required.

RIZOMA Fluid Tank Brackets



CT450B



CT451B



CT454B



CT457B

Not compatible with CT015, CT017 and CT115

For DUCATI® Panigale see at page 210 - For HONDA® CB 1000 R see at page 218 - For KAWASAKI® Z1000 see at page 228.



BRAKE / CLUTCH FLUID TANK CAPS



TP014 - TP015
TP016 - TP017
TP042



TP024 - TP025
TP026 - TP028



Ø (mm)	Thread	■	■	■	■	■
57	M52x4	TP014A	TP014B	TP014G	TP014R	TP014U
42	M37x4	TP015A	TP015B	TP015G	TP015R	TP015U
56	—	TP016A	TP016B	TP016G	TP016R	—
37	M34x4	TP017A	TP017B	TP017G	TP017R	—
62	M58x4	TP024A	TP024B	—	—	TP024U
46	M42x3	TP025A	TP025B	—	—	TP025U
49	M45x4	TP026A	TP026B	—	—	TP026U
57	M52x4	TP028A	TP028B	—	—	TP028U
39.5	M37x3	TP042A	TP042B	—	—	—



Codes and models in the following pages.

BRAKE / CLUTCH FLUID TANK CAPS

Front brake fluid tank caps

Brand	Model	Year	■	■	■	■	■
APRILIA®	RSV4	09 -	TP016A	TP016B	TP016G	TP016R	—
BMW®	F 800 GS ADVENTURE	13 -	TP024A	TP024B	—	—	TP024U
BMW®	F 800 R	09 - 14	TP024A	TP024B	—	—	TP024U
BMW®	K 1300 R	09 -	TP024A	TP024B	—	—	TP024U
BMW®	R 1200 GS	04 - 12	TP024A	TP024B	—	—	TP024U
BMW®	R 1200 GS ADVENTURE	10 - 13	TP024A	TP024B	—	—	TP024U
BMW®	R 1200 R / R 1200 R CLASSIC	06 - 14	TP024A	TP024B	—	—	TP024U
BMW®	S 1000 R	14 -	TP028A	TP028B	—	—	TP028U
BMW®	S 1000 RR	09 -	TP028A	TP028B	—	—	TP028U
DUCATI®	All ¹	All	TP016A	TP016B	TP016G	TP016R	—
HONDA®	CB 1000 R	08 -	TP014A / TP028A	TP014B / TP028B	TP014G	TP014R	TP014U / TP028U
HONDA®	CBR 600 RR / CBR 600 RR C- ABS	07 -	TP014A / TP028A	TP014B / TP028B	TP014G	TP014R	TP014U / TP028U
HONDA®	CBR 1000 RR / CBR 1000 RR C- ABS	06 -	TP014A / TP028A	TP014B / TP028B	TP014G	TP014R	TP014U / TP028U
KAWASAKI®	NINJA 600 ZX-6R	09 -	TP014A / TP028A	TP014B / TP028B	TP014G	TP014R	TP014U / TP028U
KAWASAKI®	NINJA 636 ZX-6R	02 - 06	TP014A / TP028A	TP014B / TP028B	TP014G	TP014R	TP014U / TP028U
KAWASAKI®	NINJA 900 ZX-9R	98 - 05	TP014A / TP028A	TP014B / TP028B	TP014G	TP014R	TP014U / TP028U
KAWASAKI®	NINJA 1000 ZX-10R	04 -	TP014A / TP028A	TP014B / TP028B	TP014G	TP014R	TP014U / TP028U
KAWASAKI®	Z750	07 -	TP014A / TP028A	TP014B / TP028B	TP014G	TP014R	TP014U / TP028U
KAWASAKI®	Z1000	07 - 13	TP014A / TP028A	TP014B / TP028B	TP014G	TP014R	TP014U / TP028U
KAWASAKI®	Z1000SX	07 -	TP014A / TP028A	TP014B / TP028B	TP014G	TP014R	TP014U / TP028U
KTM®	1290 SUPER DUKE R	15 -	TP016A	TP016B	TP016G	TP016R	—
KTM®	990 SUPER DUKE R	09 -	TP016A	TP016B	TP016G	TP016R	—
KTM®	990 SUPER DUKE	05 -	TP016A	TP016B	TP016G	TP016R	—
KTM®	1190 RC8 / 1190 RC8 R	08 -	TP016A	TP016B	TP016G	TP016R	—
MV AGUSTA®	F3 675	12 -	TP014A / TP028A	TP014B / TP028B	TP014G	TP014R	TP014U / TP028U
SUZUKI®	GSX R 600	01 -	TP014A / TP028A	TP014B / TP028B	TP014G	TP014R	TP014U / TP028U
SUZUKI®	GSX R 750	99 -	TP014A / TP028A	TP014B / TP028B	TP014G	TP014R	TP014U / TP028U
SUZUKI®	GSX R 1000	00 -	TP014A / TP028A	TP014B / TP028B	TP014G	TP014R	TP014U / TP028U
SUZUKI®	SV 650	All	TP014A / TP028A	TP014B / TP028B	TP014G	TP014R	TP014U / TP028U
SUZUKI®	SV 1000	All	TP014A / TP028A	TP014B / TP028B	TP014G	TP014R	TP014U / TP028U
TRIUMPH®	SCRAMBLER 900	14 -	TP014A / TP028A	TP014B / TP028B	TP014G	TP014R	TP014U / TP028U
TRIUMPH®	DAYTONA 675	06 - 12	TP014A / TP028A	TP014B / TP028B	TP014G	TP014R	TP014U / TP028U
TRIUMPH®	DAYTONA 675 R	11 -	TP016A	TP016B	TP016G	TP016R	TP016U
TRIUMPH®	SPEED TRIPLE 955	02 - 04	TP014A / TP028A	TP014B / TP028B	TP014G	TP014R	TP014U / TP028U
TRIUMPH®	SPEED TRIPLE 1050 / 1050 R	11 - 15	TP016A	TP016B	TP016G	TP016R	—
TRIUMPH®	SPEED TRIPLE 1050	05 - 10	TP014A / TP028A	TP014B / TP028B	TP014G	TP014R	TP014U / TP028U
TRIUMPH®	STREET TRIPLE R	09 - 12	TP014A / TP028A	TP014B / TP028B	TP014G	TP014R	TP014U / TP028U
YAMAHA®	YZF-R1	00 -	TP014A / TP028A	TP014B / TP028B	TP014G	TP014R	TP014U / TP028U
YAMAHA®	YZF-R6	03 -	TP014A / TP028A	TP014B / TP028B	TP014G	TP014R	TP014U / TP028U

Clutch fluid tank caps

Brand	Model	Year	■	■	■	■	■
BMW®	K 1300 R	09 -	TP025A	TP025B	—	—	TP025U
BMW®	R 1200 GS ADVENTURE	10 - 13	TP025A	TP025B	—	—	TP025U
BMW®	R 1200 GS	04 - 12	TP025A	TP025B	—	—	TP025U
BMW®	R 1200 R / R 1200 R CLASSIC	06 - 14	TP025A	TP025B	—	—	TP025U
DUCATI®	All ¹	All	TP017A	TP017B	TP017G	TP017R	—
HONDA®	CB 1000 R	08 -	TP015A	TP015B	TP015G	TP015R	TP015U
HONDA®	CBR 1000 RR	06 - 07	TP015A	TP015B	TP015G	TP015R	TP015U
KTM®	1290 SUPER DUKE R	15 -	TP042A	TP042B	—	—	—
KTM®	990 SUPER DUKE R	09 -	TP015A	TP015B	TP015G	TP015R	TP015U
KTM®	990 SUPER DUKE	05 -	TP015A	TP015B	TP015G	TP015R	TP015U
KTM®	1190 RC8 / 1190 RC8 R	08 -	TP015A	TP015B	TP015G	TP015R	TP015U

¹ Only fit on models with cylindrical tank

BRAKE / CLUTCH FLUID TANK CAPS

Rear brake fluid tank caps

Brand	Model	Year	■	■	■	■	■
BMW®	R nineT	14 -	TP026A	TP026B	—	—	TP026U
BMW®	F 800 GS ADVENTURE	13 -	TP017A	TP017B	TP017G	TP017R	—
BMW®	F 800 R	09 - 14	TP017A	TP017B	TP017G	TP017R	—
BMW®	K 1300 R	09 -	TP026A	TP026B	—	—	TP026U
BMW®	R 1200 R	15 -	TP026A	TP026B	—	—	TP026U
BMW®	R 1200 GS	04 -	TP026A	TP026B	—	—	TP026U
BMW®	R 1200 GS ADVENTURE	10 -	TP026A	TP026B	—	—	TP026U
BMW®	S 1000 R	14 -	TP026A	TP026B	—	—	TP026U
BMW®	S 1000 RR	09 -	TP026A	TP026B	—	—	TP026U
BUELL®	XB12S	08 -	TP014A / TP028A	TP014B / TP028B	TP014G	TP014R	TP014U / TP028U
DUCATI®	MULTISTRADA 1200 / 1200 S	15 -	TP026A	TP026B	—	—	TP026U
DUCATI®	DIAVEL	10 -	TP026A	TP026B	—	—	TP026U
DUCATI®	Other Models¹	All	TP017A	TP017B	TP017G	TP017R	—
HONDA®	CB 1000 R	11 -	TP014A / TP028A	TP014B / TP028B	TP014G	TP014R	TP014U / TP028U
HONDA®	CB 1000 R	08 - 10	TP015A	TP015B	TP015G	TP015R	TP015U
HONDA®	CBR 1000 RR / CBR 1000 RR C- ABS	08 -	TP015A	TP015B	TP015G	TP015R	TP015U
KAWASAKI®	ER-6F	06 - 08	TP014A / TP028A	TP014B / TP028B	TP014G	TP014R	TP014U / TP028U
KAWASAKI®	ER-6N	05 - 08	TP014A / TP028A	TP014B / TP028B	TP014G	TP014R	TP014U / TP028U
KAWASAKI®	NINJA 600 ZX-6R	09 -	TP014A / TP028A	TP014B / TP028B	TP014G	TP014R	TP014U / TP028U
KAWASAKI®	NINJA 600 ZX-6R	07 - 08	TP015A	TP015B	TP015G	TP015R	TP015U
KAWASAKI®	NINJA 1000 ZX-10R	08 -	TP015A	TP015B	TP015G	TP015R	TP015U
KAWASAKI®	NINJA 1000 ZX-10R	06 - 07	TP014A / TP028A	TP014B / TP028B	TP014G	TP014R	TP014U / TP028U
KAWASAKI®	Z750 S	05 - 06	TP014A / TP028A	TP014B / TP028B	TP014G	TP014R	TP014U / TP028U
KAWASAKI®	Z750	07 -	TP015A	TP015B	TP015G	TP015R	TP015U
KAWASAKI®	Z750	03 - 06	TP014A / TP028A	TP014B / TP028B	TP014G	TP014R	TP014U / TP028U
KAWASAKI®	Z1000 / Z1000SX	07 -	TP015A	TP015B	TP015G	TP015R	TP015U
KAWASAKI®	Z1000	03 - 06	TP014A / TP028A	TP014B / TP028B	TP014G	TP014R	TP014U / TP028U
KTM®	1290 SUPER DUKE R	15 -	TP017A	TP017B	TP017G	TP017R	—
KTM®	990 SUPER DUKE R	09 -	TP017A	TP017B	TP017G	TP017R	—
KTM®	990 SUPER DUKE	05 -	TP017A	TP017B	TP017G	TP017R	—
KTM®	1190 RC8 / 1190 RC8 R	08 -	TP017A	TP017B	TP017G	TP017R	—
SUZUKI®	GSX R 600	11 -	TP015A	TP015B	TP015G	TP015R	TP015U
SUZUKI®	GSX R 750	11 -	TP015A	TP015B	TP015G	TP015R	TP015U
TRIUMPH®	SCRAMBLER 900	14 -	TP015A	TP015B	TP015G	TP015R	TP015U
TRIUMPH®	DAYTONA 675 / 675 R	06 - 13	TP015A	TP015B	TP015G	TP015R	TP015U
TRIUMPH®	SPEED TRIPLE 1050 / 1050 R	11 - 15	TP015A	TP015B	TP015G	TP015R	TP015U
TRIUMPH®	STREET TRIPLE R	09 -	TP015A	TP015B	TP015G	TP015R	TP015U
TRIUMPH®	STREET TRIPLE	07 -	TP015A	TP015B	TP015G	TP015R	TP015U
TRIUMPH®	TIGER 800	11 -	TP015A	TP015B	TP015G	TP015R	TP015U
YAMAHA®	MT-09 TRACER / FJ-09	15 -	TP015A	TP015B	TP015G	TP015R	TP015U
YAMAHA®	MT-07 / FZ-07	14 -	TP015A	TP015B	TP015G	TP015R	TP015U
YAMAHA®	MT-09 / FZ-09	13 -	TP015A	TP015B	TP015G	TP015R	TP015U
YAMAHA®	YZF-R1	15 -	TP017A	TP017B	TP017G	TP017R	—
YAMAHA®	YZF-R1	09 - 14	TP015A	TP015B	TP015G	TP015R	TP015U
YAMAHA®	YZF-R6	06 -	TP015A	TP015B	TP015G	TP015R	TP015U



rizoma

ENGINE OIL FILLER CAPS

 MACHINED FROM BILLET ALUMINUM | SAFETY LOCK
 "QUICK UNHOOKING" SYSTEM | FIVE COLORS AVAILABLE

Brand	Model	Thread	Year	■	■	■	■	■
APRILIA®	RSV4	M25x1,5	09 -	TP021A	TP021B	TP021G	TP021R	TP021U
BMW®	R nineT	M34x1,5	14 -	TP030A ¹	—	—	—	—
BMW®	F 800 GS ADVENTURE	M24x3	13 -	—	TP101B ³	—	—	—
BMW®	R 1200 GS ADVENTURE	M34x1,5	10 -	TP030A ¹	—	—	—	—
BMW®	R 1200 GS	M34x1,5	04 -	TP030A ¹	—	—	—	—
BMW®	R 1200 R / R 1200 R CLASSIC	M34x1,5	06 - 15	TP030A ¹	—	—	—	—
BMW®	R 1200 S	M34x1,5	06 -	TP030A ¹	—	—	—	—
BMW®	S 1000 R	M24x2	14 -	TP027A	TP027B	TP027G	TP027R	TP027U
BMW®	S 1000 RR	M24x2	09 -	TP027A	TP027B	TP027G	TP027R	TP027U
BMW®	S 1000 XR	M24x2	15 -	TP027A	TP027B	TP027G	TP027R	TP027U
DUCATI®	SCRAMBLER	M20x2,5	14 -	TP008A	TP008B	TP008G	TP008R	TP008U
DUCATI®	1299 PANIGALE / 1299 PANIGALE S	M20x2,5	15 -	TP008A	TP008B	TP008G	TP008R	TP008U
DUCATI®	899 PANIGALE	M20x2,5	14 -	TP008A	TP008B	TP008G	TP008R	TP008U
DUCATI®	1199 PANIGALE / 1199 PANIGALE S	M20x2,5	12 -	TP008A	TP008B	TP008G	TP008R	TP008U
DUCATI®	848	M20x2,5	07 -	TP008A	TP008B	TP008G	TP008R	TP008U
DUCATI®	DIAVEL	M20x2,5	10 -	TP008A	TP008B	TP008G	TP008R	TP008U
DUCATI®	HYPERMOTARD SP	M20x2,5	14 -	TP008A	TP008B	TP008G	TP008R	TP008U
DUCATI®	HYPERMOTARD / HYPERSTRADA	M20x2,5	13 -	TP008A	TP008B	TP008G	TP008R	TP008U
DUCATI®	HYPERMOTARD 796	M20x2,5	09 -	TP008A	TP008B	TP008G	TP008R	TP008U
DUCATI®	MONSTER 696	M20x2,5	08 -	TP008A	TP008B	TP008G	TP008R	TP008U
DUCATI®	MONSTER 796	M20x2,5	10 -	TP008A	TP008B	TP008G	TP008R	TP008U
DUCATI®	MONSTER 821 / 1200	M20x2,5	14 -	TP008A	TP008B	TP008G	TP008R	TP008U
DUCATI®	MONSTER 1100 EVO	M20x2,5	11 -	TP008A	TP008B	TP008G	TP008R	TP008U
DUCATI®	MULTISTRADA 1200 / 1200 S	M20x2,5	10 -	TP008A	TP008B	TP008G	TP008R	TP008U
DUCATI®	STREETFIGHTER 848	M20x2,5	12 -	TP008A	TP008B	TP008G	TP008R	TP008U
DUCATI®	Other Models	M22x1,5	09 -	TP010A	TP010B	TP010G	TP010R	TP010U
HONDA®	All ²	M20x2,5	All	TP008A	TP008B	TP008G	TP008R	TP008U
KAWASAKI®	ER-6N / ER-6F	M20x2,5	09 -	TP008A	TP008B	TP008G	TP008R	TP008U
KAWASAKI®	Z800	M20x2,5	13 -	TP008A	TP008B	TP008G	TP008R	TP008U
KAWASAKI®	VERSYS 1000 ABS	M20x2,5	12 -	TP008A	TP008B	TP008G	TP008R	TP008U
KAWASAKI®	Z1000 / Z1000SX	M20x2,5	10 -	TP008A	TP008B	TP008G	TP008R	TP008U
KAWASAKI®	Other Models ³	M30x1,5	All	TP013A	TP013B	TP013G	TP013R	TP013U
KTM®	1290 SUPER DUKE R	M24x3	15 -	TP041A	TP041B	—	—	—
MV AGUSTA®	BRUTALE 675/800	M24x3	14 -	—	TP100B ⁴	—	TP100R ³	—
MV AGUSTA®	BRUTALE DRAGSTER 800	M24x3	14 -	—	TP100B ⁴	—	TP100R ³	—
MV AGUSTA®	RIVALE 800	M24x3	13 -	—	TP100B ⁴	—	TP100R ³	—
MV AGUSTA®	Other Models ⁵	M25x1,5	All	TP021A	TP021B	TP021G	TP021R	TP021U
SUZUKI®	All	M20x1,5	All	TP009A	TP009B	TP009G	TP009R	TP009U
TRIUMPH®	DAYTONA 675 / 675 R	M20x2,5	09 -	TP008A	TP008B	TP008G	TP008R	TP008U
TRIUMPH®	STREET TRIPLE RX	M20x2,5	15 -	TP008A	TP008B	TP008G	TP008R	TP008U
TRIUMPH®	STREET TRIPLE / STREET TRIPLE R	M20x2,5	09 -	TP008A	TP008B	TP008G	TP008R	TP008U
TRIUMPH®	TIGER 800 / TIGER EXPLORER	M20x2,5	11 -	TP008A	TP008B	TP008G	TP008R	TP008U
YAMAHA®	MT-09 TRACER / FJ-09	M20x2,5	15 -	TP023A	TP023B	TP023G	TP023R	TP023U
YAMAHA®	MT-09 / FZ-09	M20x2,5	13 -	TP023A	TP023B	TP023G	TP023R	TP023U
YAMAHA®	T-MAX	M20x2,5	08 -	TP023A	TP023B	TP023G	TP023R	TP023U
YAMAHA®	Other Models ⁶	M27x3	All	TP011A	TP011B	TP011G	TP011R	TP011U

¹ Warning: the TP030 has a different design (see image on page 177).

² Except models HONDA® CBR1100XX / X-11 / VFR

³ Except models KAWASAKI® ER-6 05 > 08

⁴ Oil Filler Cap with Dipstick

⁵ Except models MV AGUSTA® BRUTALE 675 / 800 / F3 675

⁶ Except models YAMAHA® MT-03 / XJR

It's a good practice to fasten the engine oil filler cap with a safety wire.
 RIZOMA engine oil filler caps come with a removable bracket for the safety wire.





MACHINED FROM BILLET ALUMINUM | ANTI-TAMPERING KEY LOCK SYSTEM
FAST AND EASY MOUNTING | BI-COLOR FINISH



KEY LOCK SYSTEM

The Key System effectively tamperproofs the cap while maintaining ease of installation and use. Even the key makes a style statement and can function as a key fob.

GAS TANK CAPS



BMW®			
Model	Year	■	■
R nineT	14 -	TF051A	TF051B
F 800 GS ADVENTURE	13 -	TF051A	TF051B
F 800 R	09 - 14	TF051A	TF051B
R 1200 GS	13 - 14	TF053A	TF053B
R 1200 GS	10 - 12	TF051A	TF051B
R 1200 R / R 1200 R CLASSIC	06 - 14	TF051A	TF051B
S 1000 R	14 -	TF051A	TF051B
S 1000 RR	09 -	TF051A	TF051B
S 1000 XR	15 -	TF053A	TF053B
DUCATI®			
Model	Year	■	■
748	All	TF041A	TF041B
848	All	TF041A	TF041B
916	All	TF041A	TF041B
996	All	TF041A	TF041B
998	All	TF041A	TF041B
1299 PANIGALE / 1299 S	15 -	TF042A	TF042B
899 PANIGALE	14 -	TF042A	TF042B
1199 PANIGALE / 1199 S	12 -	TF042A	TF042B
1098 / 1098 S	All	TF041A	TF041B
1198 / 1198 S	All	TF041A	TF041B
DIAVEL	10 -	TF040A	TF040B
SCRAMBLER	14 -	TF142A ¹	TF142B ¹
SCRAMBLER	14 -	TF042A	TF042B
MONSTER 696	08 -	TF040A	TF040B
MONSTER 796	10 -	TF040A	TF040B
MONSTER 1100 EVO	11 -	TF040A	TF040B
MONSTER 1100 / 1100 S	09 -	TF040A	TF040B
MONSTER (Other Models)	All	TF041A	TF041B
STREETFIGHTER 848	12 -	TF042A	TF042B
STREETFIGHTER / S	09 -	TF042A	TF042B
HONDA®			
Model	Year	■	■
CB 1000 R	All	TF020A ²	TF020B ²
CBF 600	04 - 06	TF020A	TF020B
CBF 1000	All	TF020A	TF020B
CBR 600 F SPORT	01 - 02	TF020A	TF020B
CBR 600 F	99 - 06	TF020A	TF020B
CBR 600 RR / CBR 600 RR C- ABS	All	TF020A	TF020B
CBR 900 RR FIREBLADE	02 - 04	TF020A	TF020B
CBR 1000 RR	All	TF020A	TF020B
HORNET 600	03 -	TF020A	TF020B
VFR 800	All	TF020A	TF020B
VTR 1000 F	All	TF020A	TF020B
VTR 1000 SP-1	00 - 01	TF020A	TF020B
VTR 1000 SP-2	02 - 06	TF020A	TF020B
KAWASAKI®			
Model	Year	■	■
ER-6F / ER-6N	09 -	TF010A	TF010B
GTR 1400	10 -	TF010A	TF010B
NINJA 600 ZX-6R	09 -	TF010A	TF010B
NINJA 1000 ZX-10R	08 -	TF010A	TF010B
VERSYS 1000 ABS	12 -	TF010A	TF010B
Z750 / Z750R	07 -	TF010A	TF010B
Z800	13 -	TF010A	TF010B
Z1000 / Z1000SX	10 -	TF010A	TF010B
ZZR 1400	08 - 10	TF010A	TF010B

¹ Attention: the TF142 has a different design (see image on dedicated pages).

² Attention: TF020 not compatible with SP model.



KTM®

Model	Year	■	■
1290 SUPER DUKE R	15 -	TF090A	TF090B

MV AGUSTA®

Model	Year	■	■
BRUTALE DRAGSTER 800	14 -	TF043A	TF043B
BRUTALE 675	12 -	TF043A	TF043B
BRUTALE 750	02 - 06	TF041A	TF041B
BRUTALE 800 / RIVALE 800	13 - 15	TF043A	TF043B
BRUTALE 910	05 - 09	TF041A	TF041B
BRUTALE 920	11 -	TF042A	TF042B
BRUTALE 989 R	07 - 09	TF041A	TF041B
BRUTALE 1078 RR	07 - 09	TF041A	TF041B
BRUTALE 1090 RR	10 -	TF042A	TF042B
F3 675	12 -	TF043A	TF043B
F4 750	00 - 02	TF041A	TF041B
F4 1000	04 - 09	TF041A	TF041B
F4 1000 RR	10 -	TF042A	TF042B

SUZUKI®

Model	Year	■	■
GLADIUS	09 -	TF070A	TF070B
GSF 650 BANDIT	05 -	TF070A	TF070B
GSF 1200S BANDIT	06 -	TF070A	TF070B
GSF 1250 BANDIT	06 -	TF070A	TF070B
GSR 600	06 -	TF070A	TF070B
GSR 750 / GSX-S750	10 -	TF070A	TF070B
GSX 650 F	08 - 10	TF070A	TF070B
GSX 1250 F	09 -	TF070A	TF070B
GSX 1300 R HAYABUSA	07 -	TF070A	TF070B
GSX R 600	06 -	TF070A	TF070B
GSX R 750	04 -	TF070A	TF070B
GSX R 1000	03 -	TF070A	TF070B
SV 650 / SV 650 S	03 -	TF070A	TF070B
SV 1000 / SV 1000 S	03 - 06	TF070A	TF070B

TRIUMPH®

Model	Year	■	■
DAYTONA 675 / 675 R	All	TF030A	TF030B
SPEED TRIPLE 1050 / 1050 R	08 - 15	TF030A	TF030B
STREET TRIPLE	All	TF030A	TF030B
TIGER 800	All	TF030A	TF030B

YAMAHA®

Model	Year	■	■
MT-09 TRACER / FJ-09	15 -	TF061A	TF061B
MT-07 / FZ-07	14 -	TF061A	TF061B
MT-09 / FZ-09	13 -	TF061A	TF061B
XJR 1300	06 -	TF061A	TF061B
FZ1 / FZ1 FAZER	All	TF061A	TF061B
FZ6 / FZ6 FAZER	All	TF061A	TF061B
FZ8	10 -	TF061A	TF061B
MT-03	All	TF061A	TF061B
XJ6 / XJ6 DIVERSION	09 -	TF061A	TF061B
XJ6 DIVERSION F	10 -	TF061A	TF061B
YZF-R1	00 -	TF061A	TF061B
YZF-R6	03 -	TF061A	TF061B



UNIVERSAL

ENGINE / FAIRING GUARDS

PRO / B-PRO / SHAPE



STRUCTURAL ELEMENT IN ALUMINUM MACHINED FROM BILLET | SLIDER IN DELRIN®
MADE SPECIFICALLY FOR EACH BIKE | AESTHETIC, LIGHTNESS AND FUNCTIONALITY

Article codes and applications on the following pages.

ENGINE / FAIRING GUARDS

BMW®



PM590A



PM580A / PM583A / PM585A



PM581B



PM582U

Model	Year	■	■	■	■	Type	
F 800 R	10 - 14	PM585A	—	—	—	B-PRO	Pair
K 1300 R	09 -	PM583A	—	—	PM583U	B-PRO	Pair
S 1000 R	14 -	—	PM581B	—	PM581U	SHAPE	Right
S 1000 R	14 -	—	PM582B	—	PM582U	SHAPE	Left
S 1000 XR	15 -	—	PM581B	—	PM581U	SHAPE	Right
S 1000 XR	15 -	—	PM582B	—	PM582U	SHAPE	Left
S 1000 XR	15 -	PM591A	—	—	PM591U	B-PRO	Pair
S 1000 RR	15 -	PM580A	—	—	PM580U	B-PRO	Pair
S 1000 RR	15 -	PM590A	—	—	PM590U	B-PRO	Pair
S 1000 RR	09 - 11	PM580A	—	—	PM580U	B-PRO	Pair
S 1000 RR	09 -	—	PM581B	—	PM581U	SHAPE	Right
S 1000 RR	09 -	—	PM582B	—	PM582U	SHAPE	Left

DUCATI®



PM505B



PM504B / PM508B
PM501B / PM502B



PM354A



PM357A



PM351B / PM509B



PM507A

Model	Year	■	■	■	■	Type	
SCRAMBLER	14 -	PM357A	—	—	—	B-PRO	Pair
DIAVEL	10 -	—	PM505B	—	—	SHAPE	Pair
HYPERMOTARD SP	14 -	—	PM508B	—	—	SHAPE	Pair
HYPERMOTARD SP	14 -	—	PM509B	—	—	PRO	Pair
HYPERMOTARD / HYPERSTRADA	13 -	—	PM508B	—	—	SHAPE	Pair
HYPERMOTARD / HYPERSTRADA	13 -	—	PM509B	—	—	PRO	Pair
HYPERMOTARD 796	09 -	—	PM351B	—	—	PRO	Pair
HYPERMOTARD 796	09 -	—	PM501B	—	—	SHAPE	Pair
MONSTER 696	08 -	—	PM351B	—	—	PRO	Pair
MONSTER 696	08 -	—	PM501B	—	—	SHAPE	Pair
MONSTER 796	10 -	—	PM351B	—	—	PRO	Pair
MONSTER 796	10 -	—	PM501B	—	—	SHAPE	Pair
MONSTER 821	14 -	PM354A	—	—	—	B-PRO	Pair
MONSTER 1000 S	03 - 05	—	PM351B	—	—	PRO	Pair
MONSTER 1000 S	03 - 05	—	PM501B	—	—	SHAPE	Pair
MONSTER 1100 / 1100 S	09 - 10	—	PM351B	—	—	PRO	Pair
MONSTER 1100 / 1100 S	09 - 10	—	PM501B	—	—	SHAPE	Pair
MONSTER 1100 EVO	11 -	—	PM351B	—	—	PRO	Pair
MONSTER 1100 EVO	11 -	—	PM501B	—	—	SHAPE	Pair
MONSTER 1200	14 -	PM354A	—	—	—	B-PRO	Pair
MULTISTRADA 1200 / 1200 S	13 - 14	PM507A	—	—	—	SHAPE	Pair
MULTISTRADA 1200 / 1200 S	10 - 12	—	PM504B	—	—	SHAPE	Pair
STREETFIGHTER / STREETFIGHTER S	09 -	—	PM502B	—	—	SHAPE	Pair
STREETFIGHTER 848	12 -	—	PM502B	—	—	SHAPE	Pair

HONDA®



PM116A



PM101B



PM114A



PM521A

Model	Year	■	■	■	■	Type	
CB 650 F	15 -	PM116A	—	—	—	B-PRO	Pair
CB 1000 R	10 -	PM114A	—	—	—	B-PRO	Pair
CB 1000 R	08 -	—	PM101B	—	—	PRO	Pair
CB 1000 R	08 -	PM521A	—	—	—	SHAPE	Left
HORNET 600 / HORNET 600 ABS	11 -	PM114A	—	—	—	B-PRO	Pair
HORNET 600	07 - 10	—	PM101B	—	—	PRO	Pair

KAWASAKI®



PM317B
PM312B / PM316B



PM584A



PM572



PM305A



PM315A



PM320A



PM571R



PM321B



PM322B

Model	Year	■	■	■	■	Type	
ER-6N / ER-6F	12 -	—	PM317B	—	—	PRO	Pair
NINJA 1000 ZX-10R	11 -	PM584A	—	—	—	B-PRO	Pair
Z750	07 -	—	PM312B	—	—	PRO	Pair
Z750 / Z750R	07 -	—	—	PM571R	—	SHAPE	Pair
Z800 / Z800 ABS	13 -	PM572A	—	—	—	SHAPE	Pair
Z1000	03 - 06	—	PM305B	—	—	SHAPE	Pair
Z1000	07 - 09	—	PM312B	—	—	PRO	Pair
Z1000	10 -	—	PM321B	—	—	SHAPE	Right
Z1000	10 - 13	—	PM316B	—	—	PRO	Pair
Z1000	10 -	PM315A	—	—	—	SHAPE	Pair
Z1000	14 -	PM320A	—	—	—	SHAPE	Pair
Z1000	14 -	—	PM322B	—	—	SHAPE	Left

ENGINE / FAIRING GUARDS

KTM®



PM463B

Model	Year	■	■	■	■	Type	
1290 SUPER DUKE R	15 -	—	PM463B	—	—	B-PRO	Pair

MV AGUSTA®



PM433B



PM434B



PM437B



PM436B



PM438B



PM435A



PM430B

Model	Year	■	■	■	■	Type	
BRUTALE DRAGSTER 800	14 -	—	PM433B	—	—	SHAPE	Right
BRUTALE DRAGSTER 800	14 -	—	PM434B	—	—	SHAPE	Left
BRUTALE DRAGSTER 800	14 -	—	PM436B	—	—	SHAPE	Left
BRUTALE DRAGSTER 800	14 -	—	PM437B	—	—	SHAPE	Right
BRUTALE 675	12 -	—	PM433B	—	—	SHAPE	Right
BRUTALE 675	12 -	—	PM434B	—	—	SHAPE	Left
BRUTALE 675	12 -	PM435A	—	—	—	B-PRO	Pair
BRUTALE 675	12 -	—	PM436B	—	—	SHAPE	Left
BRUTALE 675	12 -	—	PM437B	—	—	SHAPE	Right
BRUTALE 800 / RIVALE 800	13 - 15	—	PM433B	—	—	SHAPE	Right
BRUTALE 800 / RIVALE 800	13 - 15	—	PM434B	—	—	SHAPE	Left
BRUTALE 800 / RIVALE 800	13 - 15	PM435A	—	—	—	B-PRO	Pair
BRUTALE 800 / RIVALE 800	13 - 15	—	PM436B	—	—	SHAPE	Left
BRUTALE 800 / RIVALE 800	13 - 15	—	PM437B ¹	—	—	SHAPE	Right
RIVALE 800	13 -	—	PM438B ¹	—	—	SHAPE	Pair
BRUTALE 750	02 - 06	—	PM430B	—	—	PRO	Pair
BRUTALE 910	05 -	—	PM430B	—	—	PRO	Pair
BRUTALE 989 R	07 -	—	PM430B	—	—	PRO	Pair
BRUTALE 1078 RR	07 -	—	PM430B	—	—	PRO	Pair
F3 675	12 -	—	PM433B	—	—	SHAPE	Right
F3 675	12 -	—	PM434B	—	—	SHAPE	Left
F3 675	12 -	—	PM436B	—	—	SHAPE	Left
F3 675	12 -	—	PM437B	—	—	SHAPE	Right

¹Attention, the PM438B cannot be used with the PM437B.

SUZUKI®

PM167A



PM202B

Model	Year	■	■	■	■	Type	
GSR 600	06 -	—	PM202B	—	—	PRO	Pair
GSR 750 / GSX-S750	10 -	PM167A	—	—	—	B-PRO	Pair

TRIUMPH®

PM515A / PM253



PM251A



PM250B / PM510B



PM514A



PM530A

Model	Year	■	■	■	■	Type	
THRUXTON	15 -	PM253A	—	—	—	B-PRO	Pair
SPEED TRIPLE 955	02 - 04	—	PM250B	—	—	PRO	Pair
SPEED TRIPLE 1050 / 1050 R	11 - 15	PM251A	—	—	—	B-PRO	Pair
SPEED TRIPLE 1050	08 - 15	PM530A	—	—	—	SHAPE	Left
SPEED TRIPLE 1050	08 - 10	—	PM250B	—	—	PRO	Pair
STREET TRIPLE RX	15 -	PM514A	—	—	—	SHAPE	Pair
STREET TRIPLE RX	15 -	PM515A	—	—	—	B-PRO	Pair
STREET TRIPLE / STREET TRIPLE R	13 -	PM514A	—	—	—	SHAPE	Pair
STREET TRIPLE / STREET TRIPLE R	13 -	PM515A	—	—	—	B-PRO	Pair
STREET TRIPLE / STREET TRIPLE R	07 - 12	—	PM510B	—	—	PRO	Pair

YAMAHA®

PM212A



PM214A / PM213A / PM211A



PM202B / PM208B / PM210B



PM215B



PM553A



PM552A

Model	Year	■	■	■	■	Type	
MT-09 TRACER / FJ-09	15 -	PM212A	—	—	—	B-PRO	Pair
MT-07 / FZ-07	14 -	PM213A	—	—	—	B-PRO	Pair
MT-09 / FZ-09	13 -	PM212A	—	—	—	B-PRO	Pair
FZ1 / FZ1 FAZER	06 -	—	PM208B	—	—	PRO	Pair
FZ6 / FZ6 FAZER	04 -	—	PM202B	—	—	PRO	Pair
FZ8	10 -	—	PM211B	—	—	B-PRO	Pair
XJR 1300	15 -	PM214A	—	—	—	B-PRO	Pair
YZF-R1	15 -	—	PM215B	—	—	SHAPE	Pair
YZF-R1	09 - 14	PM552A	—	—	—	SHAPE	Right
YZF-R1	09 - 14	PM553A	—	—	—	SHAPE	Left
YZF-R6	08 -	—	PM210B	—	—	PRO	Pair





STRUCTURAL PART IN ALUMINUM MACHINED FROM BILLET | SLIDER IN DELRIN®
AVAILABLE FOR FRONT AND REAR WHEEL AXLE | AESTHETIC, LIGHTNESS AND FUNCTIONALITY

WHEEL AXLE PROTECTIONS

BMW®		Front	Rear
Model	Year		
R nineT	14 -	PW704A	—
S 1000 R	14 -	PW701A	—
S 1000 RR	09 -	PW701A	—
S 1000 XR	15 -	PW705A	—
C 600 SPORT / C 650 GT	12 -	PW703A	—

DUCATI®		Front	Rear
Model	Year		
SCRAMBLER	14 -	PW200A	PW219A
MONSTER 696	08 -	PW200A	PW201A
MONSTER 796	10 -	PW207A	PW204A
MONSTER 821	14 -	PW209A	—
MONSTER 1100 / 1100 S	09 -	PW200A	PW204A
MONSTER 1100 EVO	11 -	PW207A	PW204A
MONSTER 1200	14 -	PW206A	—
MULTISTRADA 1200 / 1200 S	10 -	PW209A	—
STREETFIGHTER / STREETFIGHTER S	09 -	PW209A	—
STREETFIGHTER 848	12 -	PW200A	PW204A
HYPERMOTARD SP	14 -	PW209A	PW204A
HYPERMOTARD / HYPERSTRADA	13 -	PW209A	PW204A
HYPERMOTARD 796	09 -	PW200A	—
HYPERMOTARD 1100 / 1100 S	07 - 09	PW200A	—
HYPERMOTARD 1100 EVO / 1100 EVO SP	10 -	PW200A	—
DIAVEL	10 -	PW206A	—
1299 PANIGALE S	15 -	PW208A	—
899 PANIGALE	14 -	PW208A	PW218A ¹
1199 PANIGALE S	12 -	PW208A	—

HONDA®		Front	Rear
Model	Year		
CB 650 F	15 -	PW064A	—
CB 1000 R	08 -	PW064A	—
CBR 600 F	10 -	PW064A	—
CBR 600 RR / 600 RR C- ABS	09 -	PW064A	PW061A
CBR 1000 RR / 1000 RR C- ABS	08 -	PW062A	PW063A
HORNET 600	11 -	PW064A	—

¹ Attention: PW218A has a different design (See image on page 211).

WHEEL AXLE PROTECTIONS

KAWASAKI®		Front	Rear
Model	Year		
Z800	13 -	PW305A	—
Z1000	10 - 13	PW305A	—
Z1000	14 -	PW308A	—
Z1000SX	14 -	PW305A	—
KTM®		Front	Rear
Model	Year		
1290 SUPER DUKE R	15 -	PW502A	—
MV AGUSTA®		Front	Rear
Model	Year		
BRUTALE DRAGSTER 800	14 -	PW553A	PW551A
BRUTALE 675	12 -	PW553A	PW551A
BRUTALE 800 / RIVALE 800	13 - 15	PW553A	PW551A
BRUTALE 910	08 -	—	PW551A
BRUTALE 920	11 -	PW550A	PW551A
BRUTALE 989 R	08 -	PW550A	PW551A
BRUTALE 1078 RR	08 -	PW550A	PW551A
BRUTALE 1090 RR	08 -	PW550A	PW551A
F3 675	12 -	PW553A	PW551A
TRIUMPH®		Front	Rear
Model	Year		
DAYTONA 675 / 675 R	09 -	—	PW453A
SPEED TRIPLE 1050 / 1050 R	11 - 15	PW461A	—
STREET TRIPLE / STREET TRIPLE R	09 - 12	PW450A	PW453A
STREET TRIPLE RX	15 -	PW454A	PW453A
YAMAHA®		Front	Rear
Model	Year		
YZF-R1	15 -	See page 281	See page 281
MT-07	14 -	PW104A	—
MT-09 TRACER / FJ-09	15 -	PW103A	—
MT-09	13 -	PW103A	—
T-MAX 500 / 530 / 530 ABS	08 - 14	PW102A	—



UNIVERSAL
REAR SET CONTROL KITS



TÜV

RRC

MACHINED FROM BILLET ALUMINUM | AVAILABLE REVERSIBLE SHIFT
CUSTOMIZABLE SETTINGS | READY TO RACE



TÜV

R
1705831

EVO

MACHINED FROM BILLET ALUMINUM | CONCEALED ADJUSTMENT SYSTEM
INTEGRAL AUTOBLOCK LOCKING SYSTEM | AVAILABLE REVERSIBLE SHIFT



TÜV

REV

MACHINED FROM BILLET ALUMINUM
HEIGHT AND LONGITUDINAL POSITION ADJUSTMENT | AVAILABLE REVERSIBLE SHIFT

REAR SET CONTROL KITS



RRC

Brand	Model	Year	■	Reversable shift
APRILIA®	RSV4	09 -	PER350B	Included
BMW®	S 1000 R	14 -	PER409B	Included
BMW®	S 1000 RR	15 -	PER411B ¹	Included
BMW®	S 1000 RR	09 - 14	PER409B	Included
DUCATI®	899 PANIGALE	14 -	PER214B	Included
DUCATI®	1199 PANIGALE	12 -	PER214B	Included
DUCATI®	1199 PANIGALE S	12 -	PER214B ²	Included
DUCATI®	848 / 1098 / 1198	09 -	PER207B	Included
HONDA®	CBR 600 RR / ABS	13 -	PER083B ³	Included
HONDA®	CBR 600 RR / ABS	07 - 12	PER081B ³	Included
HONDA®	CBR 1000 RR ABS	08 -	PER082B	Included
KAWASAKI®	Z800	13 -	PER318B ⁴	—
KAWASAKI®	NINJA 600 ZX-6R	05 -	PER314B	Included
KAWASAKI®	NINJA 636 ZX-6R	05 -	PER314B	Included
KAWASAKI®	NINJA 1000 ZX-10R	11 -	PER317B	Included
MV AGUSTA®	DRAGSTER 800	14 -	PER433B	Included
MV AGUSTA®	BRUTALE 800	13 - 15	PER433B	Included
MV AGUSTA®	BRUTALE 675	12 -	PER433B	Included
MV AGUSTA®	F3 675	12 -	PER433B	Included
SUZUKI®	GSX R 600	11 -	PER167B	Included
SUZUKI®	GSX R 750	11 -	PER167B	Included
SUZUKI®	GSX R 1000	09 -	PER167B	Included
YAMAHA®	YZF R6	06 -	PER123B	Included
YAMAHA®	YZF-R1	15 -	PER128B ¹	Included
YAMAHA®	YZF-R1	09 - 14	PER124B	Included

¹ Attention: PER411B / PER128B have a different design, Model "SPORT R" (see images on dedicated pages).

² Reverse Gear Change Option: yes with the Ducati accessory reverse quick shift lever.

³ Reverse Gear Change Option: it doesn't fit with ABS models.

⁴ The installation of the PER318B renders the Z800 a rider only motorcycles with no provision for passengers.



EVO

Brand	Model	Year	■	Reversable shift	PE606A ¹ Optional
BMW®	R nineT	14 -	PE410B ²	—	—
BMW®	K 1300 R	09 -	PE408B	—	Included
BMW®	S 1000 R	14 -	PE409B	—	Included
BMW®	S 1000 RR	09 - 14	PE409B	—	Included
DUCATI®	SCRAMBLER	15 -	PE213B ²	—	Included
DUCATI®	DIAVEL	10 -	PE212B	—	Included
HONDA®	CBR 1000 RR	08 -	PE082B	—	Included
HONDA®	CBR 1000 RR C- ABS	09 -	PE082B	—	Included
KAWASAKI®	Z1000	10 -	PE315B	—	Included
KAWASAKI®	Z1000SX	11 -	PE315B	—	Included
TRIUMPH®	SPEED TRIPLE 1050	11 - 15	PE456B	—	Included
TRIUMPH®	SPEED TRIPLE 1050 R	11 - 15	PE456B	—	Included

¹ Articulating locking adapter PE606A available. Compatible with PE630 and PE614 - See page 130.

² Attention: the PE410B / PE213B have a different design (see images on dedicated pages).



REV

Brand	Model	Year	■	Reversable shift	PE606A ¹ Optional
DUCATI®	848	07 -	PE207B	—	—
DUCATI®	1098 / 1098 S	07 - 09	PE207B	—	—
DUCATI®	1198 / 1198 S	09 - 11	PE207B	—	—
DUCATI®	HYPERMOTARD 796	10 -	PE208B	—	—
DUCATI®	HYPERMOTARD 1100 / S	07 - 09	PE208B	—	—
DUCATI®	MONSTER 600	01 - 02	PE201B	—	✓
DUCATI®	MONSTER 620	04 - 06	PE201B	—	✓
DUCATI®	MONSTER 695	06 - 08	PE201B	—	✓
DUCATI®	MONSTER 696	08 -	PE209B	Included	—
DUCATI®	MONSTER 750	01 - 02	PE201B	—	✓
DUCATI®	MONSTER 796	10 -	PE209B	Included	—
DUCATI®	MONSTER 800	03 - 05	PE201B	—	✓
DUCATI®	MONSTER 900	01 - 02	PE201B	—	✓
DUCATI®	MONSTER 1000	03 - 05	PE201B	—	✓
DUCATI®	MONSTER 1100 EVO	11 -	PE209B	Included	✓
DUCATI®	MONSTER 1100 / S	09 - 10	PE209B	Included	✓
DUCATI®	MONSTER S2 R	04 - 07	PE202B	—	✓
DUCATI®	MONSTER S4	02 - 03	PE201B	—	✓
DUCATI®	MONSTER S4R	03 - 07	PE202B	—	✓
DUCATI®	MONSTER S4RS T.S.	06 - 08	PE202B	—	✓
DUCATI®	STREETFIGHTER / S	09 -	PE211B	Included	Included
DUCATI®	STREETFIGHTER 848	12 -	PE211B	Included	Included
HONDA®	CB 1000 R	08 -	PE080B	—	✓
MV AGUSTA®	BRUTALE 750 S	03 - 05	PE430B	Included	✓
MV AGUSTA®	BRUTALE 910 S	05 - 08	PE430B	Included	✓
MV AGUSTA®	BRUTALE 920	11 -	PE430B	Included	✓
MV AGUSTA®	BRUTALE 989 R	08 -	PE430B	Included	✓
MV AGUSTA®	BRUTALE 1078 RR	08 -	PE430B	Included	✓
MV AGUSTA®	BRUTALE 1090 RR	09 -	PE430B	Included	✓
MV AGUSTA®	F4 750	00 - 02	PE430B	Included	✓
MV AGUSTA®	F4 1000	04 - 09	PE430B	Included	✓
TRIUMPH®	SPEED TRIPLE 955	02 - 04	PE450B	—	✓
TRIUMPH®	SPEED TRIPLE 1050	05 - 11	PE450B	—	✓
YAMAHA®	FZ1 / FZ1 FAZER	06 -	PE112B	—	✓











¹ Articulating locking adapter PE606A available. Compatible with PE630 and PE614 - See page 130.



PRO / B-PRO



“PRO” Rider / Passenger pegs for OEM Controls

				
PE614A	PE614B	PE614G	PE614R	PE614U
				

To mount the pegs Adaptors are required. See pages 132-133.



“B-PRO” Rider / Passenger pegs for OEM Controls

				
PE630A	PE630B	PE630G	PE630R	PE630U
				

To mount the pegs Adaptors are required. See pages 132-133.

PEGS FOR OEM MOUNTS



“PRO” Rider / Passenger peg Adapters

Brand	Model	Year	Rider	Passenger
BMW®	R nineT	14 -	PE795B	PE791A
BMW®	F 800 R	09 - 14	—	PE791A
BMW®	K 1300 R	09 -	—	PE791A
BMW®	R 1200 R / R 1200 R CLASSIC	06 -	PE795B	PE791A
BMW®	R 1200 GS	13 -	PE801B	—
BMW®	R 1200 GS ADVENTURE	14 -	PE801B	—
BMW®	S 1000 XR	15 -	PE801B	—
BMW®	S 1000 R	14 -	PE792B	PE791A
BMW®	S 1000 RR	09 -	PE792B	PE791A
BMW®	C 600 SPORT	12 - 13	—	PE797A
DUCATI®	848	08 -	PE712A	PE712A
DUCATI®	1098	07 - 09	PE712A	PE712A
DUCATI®	1198	09 - 11	PE712A	PE712A
DUCATI®	HYPERMOTARD SP	14 -	PE715B ¹	PE716B
DUCATI®	HYPERMOTARD 796	09 -	—	PE711A
DUCATI®	SCRAMBLER	14 -	PE711A	PE711A
DUCATI®	SCRAMBLER	14 -	PE715B ¹	PE711A
DUCATI®	MONSTER 696	08 -	PE711A	PE711A
DUCATI®	MONSTER 796	10 -	PE711A	PE711A
DUCATI®	MONSTER 821 / 1200	14 -	PE715B ¹	PE716B
DUCATI®	MONSTER 821 / 1200	14 -	PE716B	PE716B
DUCATI®	MONSTER 1100 / 1100 S	09 - 10	PE711A	PE711A
DUCATI®	MONSTER 1100 EVO	11 -	PE711A	PE711A
DUCATI®	MULTISTRADA 1200 / 1200 S	15 -	PE715B ¹	PE716B
DUCATI®	MULTISTRADA 1200 / 1200 S	15 -	PE716B	PE716B
DUCATI®	STREETFIGHTER / S	09 -	PE712A	PE712A
DUCATI®	STREETFIGHTER 848	12 -	PE712A	PE712A
DUCATI®	1299 PANIGALE / S	15 -	PE712A	—
DUCATI®	899 PANIGALE	14 -	PE712A	PE712A
DUCATI®	1199 PANIGALE / S	12 -	PE712A	PE712A
HONDA®	CB 650 F	15 -	PE650A	PE655A
HONDA®	CB 1000 R	08 -	—	PE655A
HONDA®	CBR 600 F	10 -	PE650A	—
HONDA®	CBR 600 F / 600 F SPORT	99 - 06	PE650A	—
HONDA®	CBR 600 RR / 600 RR C- ABS	09 -	PE650A	PE655A
HONDA®	CBR 600 RR	03 - 06	PE650A	—
HONDA®	CBR 900 RR FIREBLADE	02 - 04	PE650A	—
HONDA®	CBR 1000 RR / 1000 RR C- ABS	08 -	PE650A	PE655A
HONDA®	CBR 1000 RR	06 - 07	—	PE655A
HONDA®	HORNET 600 S	02 - 04	PE650A	—
HONDA®	HORNET 600	00 - 06	PE650A	—
HONDA®	HORNET 600 / 600 ABS	07 -	PE650A	PE654A
HONDA®	HORNET 900	02 - 06	PE650A	—
HONDA®	NC700X	12 -	—	PE655A
HONDA®	INTEGRA	12 -	—	PE655A
KAWASAKI®	ER-6N	12 -	PE750A	PE754A
KAWASAKI®	ER-6N	09 - 11	PE750A	—
KAWASAKI®	ER-6F	11 -	PE750A	PE754A
KAWASAKI®	ER-6F	09 - 10	PE750A	—
KAWASAKI®	NINJA 300	15 -	PE756B	PE757B
KAWASAKI®	NINJA 600 ZX-6R	09 -	PE753A	PE754A
KAWASAKI®	NINJA 1000 ZX-10R	06 - 07	—	PE752A
KAWASAKI®	NINJA 1000 ZX-10R	08 - 09	PE753A	PE754A

Brand	Model	Year	Rider	Passenger
KAWASAKI®	NINJA 1000 ZX-10R	11 -	PE650A	PE754A
KAWASAKI®	Z7300	15 -	PE756B	PE757B
KAWASAKI®	Z750R	11 -	PE753A	PE754A
KAWASAKI®	Z750	07 -	PE750A	PE752A
KAWASAKI®	Z750	03 - 06	PE750A	—
KAWASAKI®	Z800	13 -	PE753A	PE754A
KAWASAKI®	Z1000SX	11 - 13	PE750A	PE754A
KAWASAKI®	Z1000SX	14 -	PE750A	PE752A
KAWASAKI®	Z1000	10 -	PE753A	PE754A
KAWASAKI®	Z1000	03 - 09	PE750A	PE752A
KAWASAKI®	VERSYS 1000 ABS	12 -	PE750A	PE754A
KTM®	1290 SUPER DUKE R	15 -	PE852B	—
KTM®	1190 RC8 / 1190 RC8 R	08 -	PE760A	—
MV AGUSTA®	BRUTALE DRAGSTER 800	14 -	PE712A	PE722A
MV AGUSTA®	BRUTALE 675	12 -	PE712A	PE722A
MV AGUSTA®	BRUTALE 800 / RIVALE 800	13 - 15	PE712A	PE722A
MV AGUSTA®	BRUTALE 750 S	02 - 06	PE712A	PE712A
MV AGUSTA®	BRUTALE 910 S	05 -	PE712A	PE712A
MV AGUSTA®	BRUTALE 920	11 -	PE712A	PE712A
MV AGUSTA®	BRUTALE 989 R	07 -	PE712A	PE712A
MV AGUSTA®	BRUTALE 1078 RR	07 -	PE712A	PE712A
MV AGUSTA®	BRUTALE 1090 RR	09 -	PE712A	PE712A
MV AGUSTA®	F3 675	12 -	PE712A	PE722A
MV AGUSTA®	F4 750	00 - 02	PE712A	PE712A
MV AGUSTA®	F4 1000	04 - 09	PE712A	PE712A
SUZUKI®	GSR 750 / GSX-S750	10 -	PE692A	PE693A
SUZUKI®	GSX R 600	08 -	PE692A	PE693A
SUZUKI®	GSX R 750	08 -	PE692A	PE693A
SUZUKI®	GSX R 1000	09 -	PE692A	PE693A
TRIUMPH®	THRUXTON	15 -	PE770B	PE771B
TRIUMPH®	BONNEVILLE T100	14 -	PE766B	PE767B
TRIUMPH®	SCRAMBLER 900	14 -	PE766B	PE767B
TRIUMPH®	DAYTONA 675 / 675 R	09 -	PE760A	PE762A
TRIUMPH®	SPEED TRIPLE 1050 / 1050 R	11 - 15	PE760A	PE762A
TRIUMPH®	SPEED TRIPLE 1050	08 - 10	—	PE762A
TRIUMPH®	STREET TRIPLE RX	15 -	PE760A	PE762A
TRIUMPH®	STREET TRIPLE R	09 -	PE760A	PE762A
TRIUMPH®	STREET TRIPLE	07 -	PE760A	PE762A
YAMAHA®	MT-09 TRACER / FJ-09	15 -	PE679B	PE676A
YAMAHA®	MT-07 / FZ-07	14 -	PE677B	PE676A
YAMAHA®	MT-09 / FZ-09	13 -	PE679B	PE676A
YAMAHA®	FZ1 / FZ1 FAZER	06 -	—	PE676A
YAMAHA®	FZ8	10 -	—	PE676A
YAMAHA®	T-MAX 500 / 530 / 530 ABS	04 -	—	PE676A
YAMAHA®	XV950R	14 -	PE681B	PE682B
YAMAHA®	XJR 1300	15 -	—	PE676A
YAMAHA®	XJ6	08 -	PE677B	PE676A
YAMAHA®	YZF-R1	02 -	PE672A	PE674A
YAMAHA®	YZF-R6	03 -	PE672A	PE674A

¹ PE715B: Eccentric Rider Peg Adapter.

“B-PRO” Rider / Passenger peg Adapters

Brand	Model	Year	Rider	Passenger
BMW®	R nineT	14 -	PE795B	PE791A
BMW®	F 800 R	09 - 14	—	PE791A
BMW®	K 1300 R	09 -	—	PE791A
BMW®	R 1200 R / R 1200 R CLASSIC	06 -	PE795B	PE791A
BMW®	R 1200 GS	13 -	PE801B	—
BMW®	R 1200 GS ADVENTURE	14 -	PE801B	—
BMW®	S 1000 XR	15 -	PE801B	—
BMW®	S 1000 R	14 -	PE792B	PE791A
BMW®	S 1000 RR	09 -	PE792B	PE791A
BMW®	C 600 SPORT	12 - 13	—	PE797A
DUCATI®	848	08 -	PE712A	PE712A
DUCATI®	1098	07 - 09	PE712A	PE712A
DUCATI®	1198	09 - 11	PE712A	PE712A
DUCATI®	HYPERMOTARD SP	14 -	PE715B ¹	PE716B
DUCATI®	HYPERMOTARD 796	09 -	—	PE711A
DUCATI®	SCRAMBLER	14 -	PE711A	PE711A
DUCATI®	SCRAMBLER	14 -	PE715B ¹	PE711A
DUCATI®	MONSTER 696	08 -	PE711A	PE711A
DUCATI®	MONSTER 796	10 -	PE711A	PE711A
DUCATI®	MONSTER 821 / 1200	14 -	PE715B ¹	PE716B
DUCATI®	MONSTER 821 / 1200	14 -	PE716B	PE716B
DUCATI®	MONSTER 1100 / 1100 S	09 - 10	PE711A	PE711A
DUCATI®	MONSTER 1100 EVO	11 -	PE711A	PE711A
DUCATI®	MULTISTRADA 1200 / 1200 S	15 -	PE715B ¹	PE716B
DUCATI®	MULTISTRADA 1200 / 1200 S	15 -	PE716B	PE716B
DUCATI®	STREETFIGHTER / S	09 -	PE712A	PE712A
DUCATI®	STREETFIGHTER 848	12 -	PE712A	PE712A
DUCATI®	1299 PANIGALE / S	15 -	PE712A	—
DUCATI®	899 PANIGALE	14 -	PE712A	PE712A
DUCATI®	1199 PANIGALE / S	12 -	PE712A	PE712A
HONDA®	CB 650 F	15 -	PE650A	PE655A
HONDA®	CB 1000 R	08 -	—	PE655A
HONDA®	CBR 600 F	10 -	PE650A	—
HONDA®	CBR 600 F / 600 F SPORT	99 - 06	PE650A	—
HONDA®	CBR 600 RR / 600 RR C- ABS	09 -	PE650A	PE655A
HONDA®	CBR 600 RR	03 - 06	PE650A	—
HONDA®	CBR 900 RR FIREBLADE	02 - 04	PE650A	—
HONDA®	CBR 1000 RR / 1000 RR C- ABS	08 -	PE650A	PE655A
HONDA®	CBR 1000 RR	06 - 07	—	PE655A
HONDA®	HORNET 600 S	02 - 04	PE650A	—
HONDA®	HORNET 600	00 - 06	PE650A	—
HONDA®	HORNET 600 / 600 ABS	07 -	PE650A	PE654A
HONDA®	HORNET 900	02 - 06	PE650A	—
HONDA®	NC700X	12 -	—	PE655A
HONDA®	INTEGRA	12 -	—	PE655A
KAWASAKI®	ER-6N	12 -	PE750A	PE754A
KAWASAKI®	ER-6N	09 - 11	PE750A	—
KAWASAKI®	ER-6F	11 -	PE750A	PE754A
KAWASAKI®	ER-6F	09 - 10	PE750A	—
KAWASAKI®	NINJA 300	15 -	PE756B	PE757B
KAWASAKI®	NINJA 600 ZX-6R	09 -	PE753A	PE754A
KAWASAKI®	NINJA 1000 ZX-10R	06 - 07	—	PE752A
KAWASAKI®	NINJA 1000 ZX-10R	08 - 09	PE753A	PE754A

Brand	Model	Year	Rider	Passenger
KAWASAKI®	NINJA 1000 ZX-10R	11 -	PE650A	PE754A
KAWASAKI®	Z750R	11 -	PE753A	PE754A
KAWASAKI®	Z750	07 -	PE750A	PE752A
KAWASAKI®	Z750	03 - 06	PE750A	—
KAWASAKI®	Z800	13 -	PE753A	PE754A
KAWASAKI®	Z1000SX	11 - 13	PE750A	PE754A
KAWASAKI®	Z1000SX	14 -	PE750A	PE752A
KAWASAKI®	Z1000	10 -	PE753A	PE754A
KAWASAKI®	Z1000	03 - 09	PE750A	PE752A
KAWASAKI®	VERSYS 1000 ABS	12 -	PE750A	PE754A
KTM®	1290 SUPER DUKE R	15 -	PE852B	PE854B
KTM®	1190 RC8 / 1190 RC8 R	08 -	PE760A	—
MV AGUSTA®	BRUTALE DRAGSTER 800	14 -	PE712A	PE722A
MV AGUSTA®	BRUTALE 675	12 -	PE712A	PE722A
MV AGUSTA®	BRUTALE 800 / RIVALE 800	13 - 15	PE712A	PE722A
MV AGUSTA®	BRUTALE 750 S	02 - 06	PE712A	PE712A
MV AGUSTA®	BRUTALE 910 S	05 -	PE712A	PE712A
MV AGUSTA®	BRUTALE 920	11 -	PE712A	PE712A
MV AGUSTA®	BRUTALE 989 R	07 -	PE712A	PE712A
MV AGUSTA®	BRUTALE 1078 RR	07 -	PE712A	PE712A
MV AGUSTA®	BRUTALE 1090 RR	09 -	PE712A	PE712A
MV AGUSTA®	F3 675	12 -	PE712A	PE722A
MV AGUSTA®	F4 750	00 - 02	PE712A	PE712A
MV AGUSTA®	F4 1000	04 - 09	PE712A	PE712A
SUZUKI®	GSR 750 / GSX-S750	10 -	PE692A	PE693A
SUZUKI®	GSX R 600	08 -	PE692A	PE693A
SUZUKI®	GSX R 750	08 -	PE692A	PE693A
SUZUKI®	GSX R 1000	09 -	PE692A	PE693A
TRIUMPH®	THRUXTON	15 -	PE770B	PE771B
TRIUMPH®	BONNEVILLE T100	14 -	PE766B	PE767B
TRIUMPH®	SCRAMBLER 900	14 -	PE766B	PE767B
TRIUMPH®	DAYTONA 675 / 675 R	09 -	PE760A	PE762A
TRIUMPH®	SPEED TRIPLE 1050 / 1050 R	11 - 15	PE760A	PE762A
TRIUMPH®	SPEED TRIPLE 1050	08 - 10	—	PE762A
TRIUMPH®	STREET TRIPLE RX	15 -	PE760A	PE762A
TRIUMPH®	STREET TRIPLE R	09 -	PE760A	PE762A
TRIUMPH®	STREET TRIPLE	07 -	PE760A	PE762A
YAMAHA®	MT-09 TRACER / FJ-09	15 -	PE679B	PE676A
YAMAHA®	MT-07 / FZ-07	14 -	PE677B	PE676A
YAMAHA®	MT-09 / FZ-09	13 -	PE679B ¹	PE676A
YAMAHA®	FZ1 / FZ1 FAZER	06 -	—	PE676A
YAMAHA®	FZ8	10 -	—	PE676A
YAMAHA®	T-MAX 500 / 530 / 530 ABS	04 -	—	PE676A
YAMAHA®	XV950R	14 -	PE681B	PE682B
YAMAHA®	XJR 1300	15 -	—	PE676A
YAMAHA®	XJ6	08 -	PE677B	PE676A
YAMAHA®	YZF-R1	02 - 14	PE672A	PE674A
YAMAHA®	YZF-R6	03 -	PE672A	PE674A

¹ PE715B: Eccentric Rider Peg Adapter





“STREET” Pegs



PE642B

To mount the pegs Adaptors are required. See page 136.



STREET

MACHINED FROM BILLET ALUMINUM
 MAXIMUM FEELING, RIDING COMFORT AND GRIP | STYLE AND FUNCTIONALITY



“TOURING” Pegs



PE622A

PE622B

PE622G

PE622R

PE622U



To mount the pegs Adaptors are required. See page 137.



TOURING

MACHINED FROM BILLET ALUMINUM | TOOTHED CHANGEABLE PINS MADE OF ERGAL
 STYLE AND FUNCTIONALITY | OPTIONAL: ANTI-VIBRATION RUBBER KIT

PEGS FOR OEM MOUNTS



“STREET” Peg Adaptors

Brand	Model	Year	Rider	Passenger
BMW®	R nineT	14 -	PE795B	PE786B
BMW®	F 800 R	09 - 14	—	PE791A
BMW®	K 1300 R	09 -	—	PE791A
BMW®	R 1200 R / R 1200 R CLASSIC	06 -	PE795B	PE791A
BMW®	R 1200 GS	13 -	PE801B	—
BMW®	R 1200 GS ADVENTURE	14 -	PE801B	—
BMW®	S 1000 XR	15 -	PE801B	—
BMW®	S 1000 R	14 -	—	PE791A
BMW®	S 1000 RR	09 - 14	—	PE791A
BMW®	C 600 SPORT	12 - 13	—	PE797A
DUCATI®	848	08 -	PE712A	PE712A
DUCATI®	1098	07 - 09	PE712A	PE712A
DUCATI®	1198	09 - 11	PE712A	PE712A
DUCATI®	HYPERMOTARD SP	14 -	PE715B ¹	—
DUCATI®	HYPERMOTARD 796	09 -	—	PE711A
DUCATI®	SCRAMBLER	14 -	PE711A	PE711A
DUCATI®	SCRAMBLER	14 -	PE715B ²	PE711A
DUCATI®	MONSTER 696	08 -	PE711A	PE711A
DUCATI®	MONSTER 796	10 -	PE711A	PE711A
DUCATI®	MONSTER 821 / 1200	14 -	PE715B ¹	PE716B
DUCATI®	MONSTER 821 / 1200	14 -	PE716B	PE716B
DUCATI®	MONSTER 1100 / 1100 S	09 - 10	PE711A	PE711A
DUCATI®	MONSTER 1100 EVO	11 -	PE711A	PE711A
DUCATI®	MULTISTRADA 1200 / 1200 S	15 -	PE715B ¹	PE716B
DUCATI®	MULTISTRADA 1200 / 1200 S	15 -	PE716B	PE716B
DUCATI®	STREETFIGHTER / S	09 -	PE712A	PE712A
DUCATI®	STREETFIGHTER 848	12 -	PE712A	PE712A
DUCATI®	1299 PANIGALE / S	15 -	PE712A	—
DUCATI®	899 PANIGALE	14 -	PE712A	PE712A
DUCATI®	1199 PANIGALE / S	12 -	PE712A	PE712A
HONDA®	CB 650 F	15 -	PE650A	PE655A
HONDA®	CB 1000 R	08 -	—	PE655A
HONDA®	CBR 600 F	10 -	PE650A	—
HONDA®	CBR 600 F / 600 F SPORT	99 - 06	PE650A	—
HONDA®	CBR 600 RR / 600 RR C- ABS	09 -	PE650A	PE655A
HONDA®	CBR 600 RR	03 - 06	PE650A	—
HONDA®	CBR 900 RR FIREBLADE	02 - 04	PE650A	—
HONDA®	CBR 1000 RR / 1000 RR C- ABS	08 -	PE650A	PE655A
HONDA®	CBR 1000 RR	06 - 07	—	PE655A
HONDA®	HORNET 600 S	02 - 04	PE650A	—
HONDA®	HORNET 600	00 - 06	PE650A	—
HONDA®	HORNET 600 / 600 ABS	07 -	PE650A	PE654A
HONDA®	HORNET 900	02 - 06	PE650A	—
HONDA®	NC700X	12 -	—	PE655A
HONDA®	INTEGRA	12 -	—	PE655A
KAWASAKI®	ER-6N	12 -	PE750A	PE754A
KAWASAKI®	ER-6N	09 - 11	PE750A	—
KAWASAKI®	ER-6F	11 -	PE750A	PE754A
KAWASAKI®	ER-6F	09 - 10	PE750A	—
KAWASAKI®	NINJA 600 ZX-6R	09 -	PE753A	PE754A
KAWASAKI®	NINJA 1000 ZX-10R	06 - 07	—	PE752A
KAWASAKI®	NINJA 1000 ZX-10R	08 - 09	PE753A	PE754A

Brand	Model	Year	Rider	Passenger
KAWASAKI®	NINJA 1000 ZX-10R	11 -	PE650A	PE754A
KAWASAKI®	Z750R	11 -	PE753A	PE754A
KAWASAKI®	Z750	07 -	PE750A	PE752A
KAWASAKI®	Z750	03 - 06	PE750A	—
KAWASAKI®	Z800	13 -	PE753A	PE754A
KAWASAKI®	Z1000SX	11 - 13	PE750A	PE754A
KAWASAKI®	Z1000SX	14 -	PE750A	PE752A
KAWASAKI®	Z1000	10 -	PE753A	PE754A
KAWASAKI®	Z1000	03 - 09	PE750A	PE752A
KAWASAKI®	VERSYS 1000 ABS	12 -	PE750A	PE754A
KTM®	1290 SUPER DUKE R	15 -	PE852B	PE854B
KTM®	1190 RC8 / 1190 RC8 R	08 -	PE760A	—
MV AGUSTA®	BRUTALE DRAGSTER 800	14 -	PE712A	PE722A
MV AGUSTA®	BRUTALE 675	12 -	PE712A	PE722A
MV AGUSTA®	BRUTALE 800 / RIVALE 800	13 - 15	PE712A	PE722A
MV AGUSTA®	BRUTALE 750 S	02 - 06	PE712A	PE712A
MV AGUSTA®	BRUTALE 910 S	05 -	PE712A	PE712A
MV AGUSTA®	BRUTALE 920	11 -	PE712A	PE712A
MV AGUSTA®	BRUTALE 989 R	07 -	PE712A	PE712A
MV AGUSTA®	BRUTALE 1078 RR	07 -	PE712A	PE712A
MV AGUSTA®	BRUTALE 1090 RR	09 -	PE712A	PE712A
MV AGUSTA®	F3 675	12 -	PE712A	PE722A
MV AGUSTA®	F4 750	00 - 02	PE712A	PE712A
MV AGUSTA®	F4 1000	04 - 09	PE712A	PE712A
SUZUKI®	GSR 750 / GSX-S750	10 -	PE692A	PE693A
SUZUKI®	GSX R 600	08 -	PE692A	PE693A
SUZUKI®	GSX R 750	08 -	PE692A	PE693A
SUZUKI®	GSX R 1000	09 -	PE692A	PE693A
TRIUMPH®	THRUXTON	15 -	PE770B	PE771B
TRIUMPH®	BONNEVILLE T100	14 -	PE766B	PE767B
TRIUMPH®	SCRAMBLER 900	14 -	PE766B	PE767B
TRIUMPH®	DAYTONA 675 / 675 R	09 -	PE760A	PE762A
TRIUMPH®	SPEED TRIPLE / 1050 R	11 - 15	PE760A	PE762A
TRIUMPH®	SPEED TRIPLE 1050	08 - 10	—	PE762A
TRIUMPH®	STREET TRIPLE RX	15 -	PE760A	PE762A
TRIUMPH®	STREET TRIPLE R	09 -	PE760A	PE762A
TRIUMPH®	STREET TRIPLE	07 -	PE760A	PE762A
YAMAHA®	MT-09 TRACER / FJ-09	15 -	PE679B	PE676A
YAMAHA®	MT-07 / FZ-07	14 -	PE677B	PE676A
YAMAHA®	MT-09 / FZ-09	13 -	PE679B	PE676A
YAMAHA®	FZ1 / FZ1 FAZER	06 -	—	PE676A
YAMAHA®	FZ8	10 -	—	PE676A
YAMAHA®	T-MAX 500 / 530 / 530 ABS	04 -	—	PE676A
YAMAHA®	XV950R	14 -	PE681B	PE682B
YAMAHA®	XJR 1300	15 -	—	PE676B
YAMAHA®	XJ6	08 -	PE677B	PE676A
YAMAHA®	YZF-R1	02 - 14	PE672A	PE674A
YAMAHA®	YZF-R6	03 -	PE672A	PE674A

¹ PE715B: Eccentric Rider Peg Adapter



“TOURING” Peg Adaptors

Brand	Model	Year	Rider	Passenger
BMW®	R nineT	14 -	PE796B	—
BMW®	F 800 GS ADVENTURE	13 -	PE793A	PE799A
BMW®	R 1150 GS / R 1150 GS ABS	02 -	PE793A	—
BMW®	R 1150 GS ADVENTURE	02 -	PE793A	—
BMW®	R 1200 GS ADVENTURE	14 -	PE798A	PE800A
BMW®	R 1200 GS ADVENTURE	10 -13	PE793A	—
BMW®	R 1200 GS	13 -	PE798A	PE800A
BMW®	R 1200 GS	04 - 12	PE793A	—
BMW®	R 1200 R / R 1200 R CLASSIC	06 - 15	PE796B	—
BMW®	S 1000 XR	15 -	PE798A	PE800A
DUCATI®	SCRAMBLER	14 -	PE713A	—
DUCATI®	HYPERMOTARD / HYPERSTRADA	13 -	PE713A	—
DUCATI®	HYPERMOTARD 796	09 -	PE713A	—
DUCATI®	HYPERMOTARD 1100 / 1100 S	07 - 09	PE713A	—
DUCATI®	MULTISTRADA 1200 / 1200 S	10 -	PE713A	—
HONDA®	CB 650 F	15 -	PE663B	—
KTM®	1290 SUPER DUKE R	15 -	PE853B	—
KTM®	990 SUPERMOTO R	09 -	PE850A	—
KTM®	990 SUPERMOTO T ABS	11 -	PE850A	—
KTM®	990 SUPERMOTO T	09 -	PE850A	—
KTM®	990 ADVENTURE	09 -	PE850A	—
KTM®	990 ADVENTURE R	09 -	PE850A	—
MV AGUSTA®	RIVALE 800	13 -	PE723A	—
TRIUMPH®	BONNEVILLE T100	14 -	PE768B	PE769B
TRIUMPH®	TIGER 800 / 800 XC / EXPLORER	11 -	PE765A	—
YAMAHA®	MT-09 TRACER / FJ-09	15 -	PE684B	—
YAMAHA®	XT1200Z SUPER TENERE	11 -	PE678A	—



“TOURING” Pegs rubber KIT

■
RB622B

016NEW



UNIVERSAL HEADLIGHT FAIRING



MOLDED FROM A SHEET OF HIGH QUALITY BRUSHED AND ANODIZED ALUMINUM
TWO COLORS AVAILABLE | CLASSIC STYLE | IMPROVED AERODYNAMICS

CF010A

CF010B

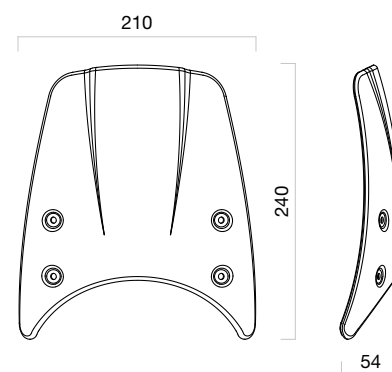

016NEW



UNIVERSAL FRONT FENDER



MOLDED FROM A SHEET OF HIGH QUALITY BRUSHED AND ANODIZED ALUMINUM
TWO COLORS AVAILABLE | CLASSIC STYLE

■	■
FD001A	FD001B
FD002A	FD002B

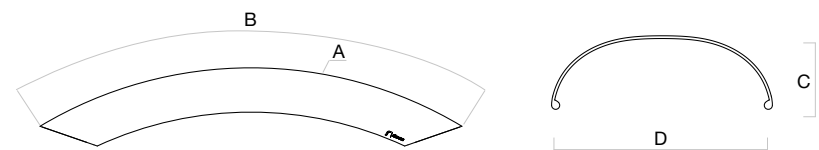

Art.	A (mm)	B (mm)	C (mm)	D (mm)	Wheel
FD001	370	400	40	120	17/18"
FD002	360	390	51	140	17/18"

016NEW



UNIVERSAL REAR FENDER



MOLDED FROM A SHEET OF HIGH QUALITY BRUSHED AND ANODIZED ALUMINUM
TWO COLORS AVAILABLE | CLASSIC STYLE

■	■
FD011A	FD011B
FD012A	FD012B

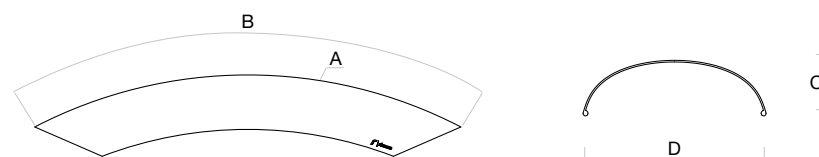
Art.	A (mm)	B (mm)	C (mm)	D (mm)	Wheel
FD011	370	360	51	140	17/18"
FD012	450	300	46	180	17/18"



UNIVERSAL
LICENSE PLATE SUPPORT
FOX



USA VERSION

Each kit includes a USA size plate holder.



MEETS EUROPEAN STANDARDS | MACHINED FROM BILLET ALUMINUM
E-HOMOLOGATED LED SMD LICENSE LIGHT | FAST EASY INSTALL

The KIT includes



LICENSE PLATE SUPPORT

Brand	Model	Year	■
APRILIA®	RSV4	09 -	PT800B
APRILIA®	TUONO V4 R / V4 R APRC	11 -	PT800B
BMW®	S 1000 XR	15 -	PT715B
BMW®	R nineT	14 -	PT709B ¹
BMW®	R nineT	14 -	PT711B ^{1/3}
BMW®	S 1000 R	14 -	PT704B ^{1/3}
BMW®	S 1000 RR	09 -	PT704B ^{1/3}
BMW®	C 600 SPORT	12 -	PT705B ³
DUCATI®	848	08 -	PT503B
DUCATI®	1098 / 1098 S	07 - 09	PT503B
DUCATI®	1198 / 1198 S	09 - 11	PT503B
DUCATI®	1299 PANIGALE / 1299 PANIGALE S	15 -	PT514B
DUCATI®	899 PANIGALE	14 -	PT514B
DUCATI®	1199 PANIGALE / 1199 PANIGALE S	12 -	PT514B
DUCATI®	SCRAMBLER	14 -	PT526B
DUCATI®	MONSTER 600	94 - 02	PT500B
DUCATI®	MONSTER 620	02 - 06	PT500B
DUCATI®	MONSTER 695	06 - 08	PT500B
DUCATI®	MONSTER 696	08 -	PT511B ^{1/3}
DUCATI®	MONSTER 750	96 - 02	PT500B
DUCATI®	MONSTER 796	10 -	PT511B ^{1/3}
DUCATI®	MONSTER 800	03 - 05	PT500B
DUCATI®	MONSTER 821	14 -	PT517B ³
DUCATI®	MONSTER 900	93 - 02	PT500B
DUCATI®	MONSTER 1000	03 - 05	PT500B
DUCATI®	MONSTER 1000 S	03 - 05	PT511B ^{1/3}
DUCATI®	MONSTER 1100 / 1100 S	09 -	PT511B ^{1/3}
DUCATI®	MONSTER 1100 EVO	11 -	PT511B ^{1/3}
DUCATI®	MONSTER S2 R	04 - 07	PT500B
DUCATI®	MONSTER S2R 1000	05 - 07	PT500B
DUCATI®	MONSTER S4	02 - 03	PT500B
DUCATI®	MONSTER S4R	03 - 07	PT500B
DUCATI®	HYPERMOTARD / HYPERSTRADA	13 -	PT515B
DUCATI®	HYPERMOTARD SP	14 -	PT515B
DUCATI®	MULTISTRADA 1200 / 1200 S	10 - 14	PT508B
DUCATI®	STREETFIGHTER / STREETFIGHTER S	09 -	PT506B
DUCATI®	STREETFIGHTER 848	12 -	PT506B
HONDA®	CB 650 F	15 -	PT111B
HONDA®	CB 1000 R	08 -	PT103B
HONDA®	CBR 600 F	11 -	PT105B
HONDA®	CBR 600 RR / 600 RR C- ABS	13 -	PT109B
HONDA®	CBR 600 RR / 600 RR C- ABS	07 - 12	PT101B ²
HONDA®	CBR 600 RR	03 - 06	PT100B
HONDA®	CBR 1000 RR / 1000 RR C- ABS	10 -	PT104B
HONDA®	CBR 1000 RR	04 - 07	PT100B
HONDA®	HORNET 600 / 600 ABS	11 -	PT105B
HONDA®	INTEGRA	12 -	PT106B ²
HONDA®	NC700X / XD / S / SD	12 -	PT106B ²
KAWASAKI®	ER-6N / ER-6F	12 -	PT314B

Brand	Model	Year	■
KAWASAKI®	NINJA 300	15 -	PT316B
KAWASAKI®	NINJA 300	15 -	PT317B ⁵
KAWASAKI®	NINJA 600 ZX-6R	09 -	PT307B
KAWASAKI®	NINJA 636 ZX-6R	09 -	PT307B
KAWASAKI®	NINJA 1000 ZX-10R	11 -	PT312B
KAWASAKI®	NINJA 1000 ZX-10R	08 - 10	PT307B
KAWASAKI®	Z300	15 -	PT316B
KAWASAKI®	Z300	15 -	PT317B ⁵
KAWASAKI®	Z750R	11 -	PT311B
KAWASAKI®	Z750	07 -	PT306B
KAWASAKI®	Z800 / Z800 ABS	13 -	PT313B
KAWASAKI®	Z1000	14 -	PT315B
KAWASAKI®	Z1000 / Z1000SX	10 -	PT310B
KAWASAKI®	Z1000	07 - 09	PT306B
KTM®	1290 SUPER DUKE R	15 -	PT681B
MV AGUSTA®	F3 675	12 -	PT603B
MV AGUSTA®	BRUTALE 675	12 -	PT604B
MV AGUSTA®	BRUTALE 800	13 - 15	PT604B
MV AGUSTA®	BRUTALE 920	11 -	PT601B
MV AGUSTA®	BRUTALE 1090 RR	09 -	PT601B
SUZUKI®	GSX R 600	11 -	PT407B
SUZUKI®	GSX R 750	11 -	PT407B
SUZUKI®	GSX R 1000	09 -	PT406B
SUZUKI®	GSR 750 / GSX-S750	10 -	PT408B
TRIUMPH®	THRUXTON	15 -	PT657B
TRIUMPH®	THRUXTON	15 -	PT660B ⁴
TRIUMPH®	BONNEVILLE T100	14 -	PT657B
TRIUMPH®	SCRAMBLER 900	14 -	PT657B
TRIUMPH®	DAYTONA 675 / 675 R	13 -	PT656B ³
TRIUMPH®	SPEED TRIPLE 1050 / 1050 R	11 - 15	PT654B ³
TRIUMPH®	STREET TRIPLE RX	15 -	PT659B ³
TRIUMPH®	STREET TRIPLE / STREET TRIPLE R	13 -	PT656B ³
TRIUMPH®	STREET TRIPLE / STREET TRIPLE R	07 - 12	PT651B
YAMAHA®	XV950R	14 -	PT218B
YAMAHA®	MT-09 TRACER / FJ-09	15 -	PT214B
YAMAHA®	MT-07 / FZ-07	14 -	PT215B ³
YAMAHA®	MT-09 / FZ-09	13 -	PT214B
YAMAHA®	FZ1	06 -	PT205B
YAMAHA®	FZ8	10 -	PT212B
YAMAHA®	T-MAX 530 / 530 ABS	12 -	PT213B
YAMAHA®	T-MAX 500	08 -	PT209B ¹
YAMAHA®	XJR 1300	15 -	PT216B ^{1/2/3}
YAMAHA®	XJR 1300	15 -	PT217B
YAMAHA®	XJ6	09 -	PT208B
YAMAHA®	YZF-R1	15 -	PT219B
YAMAHA®	YZF-R1	09 - 14	PT210B
YAMAHA®	YZF-R1	04 - 08	PT207B
YAMAHA®	YZF-R6	06 -	PT204B

¹ Tail unit included.

² Rear Light Included.

³ OEM indicator light brackets included.

⁴ PT660B: not compatible with OEM fender.

⁵ The Rizoma License Plate Support PT317B contains only the USA plate holder.



USA VERSION
Each kit includes a USA size plate holder.

Universal license plate support



Type	■
Universal	PT061B

The universal license plate holder offers the outstanding performance of all RIZOMA products. With its adjustable mounting plates, it is easy to mount to a wide range of makes and models.

With a range of angle and extension adjustment, it is equipped with a reflector and the latest SMD LED lights, for full compliance with European legal requirements.

Our license plate support kit includes:

- License plate support light
- Reflector
- 157x157 mm support
- 146x69.5 mm support
- Indicator light supports



Universal license plate support "BASIC"



Type	■
Universal "BASIC"	PT062B

This cutdown version is not equipped with a reflector or light, for situations in which they are not legally required or the bike is already fitted with them.

Our license plate support kit includes: 146x69.5 mm support, Indicator light supports

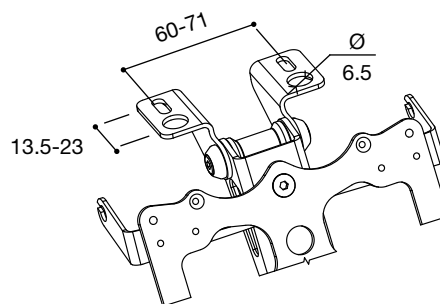

License plate support light (with bracket)



■
EE091B



Reflector KIT (with bracket)



■
EE045H



UNIVERSAL LICENSE PLATE SUPPORT SIDE ARM



USA VERSION

Each kit includes a USA size plate holder.



MEETS EUROPEAN STANDARDS | MACHINED FROM BILLET ALUMINUM
E-HOMOLOGATED LED SMD LICENSE LIGHT

Brand	Model	Year	■
BMW®	R nineT	14 -	PT706B ¹
DUCATI®	HYPERMOTARD SP	14 -	PT516B
DUCATI®	HYPERMOTARD / HYPERSTRADA	13 -	PT516B
DUCATI®	DIAVEL	10 -	PT509B
DUCATI®	MONSTER 796	10 -	PT512B ^{1/2}
DUCATI®	MONSTER 1100 EVO	11 -	PT512B ^{1/2}
DUCATI®	MONSTER 1200	14 -	PT519B
HONDA®	CB 1000 R / CB 1000 R ABS	11 -	PT107B
MV AGUSTA®	BRUTALE 675	12 -	PT605B
MV AGUSTA®	BRUTALE 800 / RIVALE 800	13 - 15	PT605B
TRIUMPH®	SPEED TRIPLE 1050 / 1050 R	11 - 15	PT655B

¹ Tail unit included.

² OEM indicator light brackets included.

The KIT includes



The Rizoma "SIDE ARM" License plate Supports are compatible with the Rizoma Carbon rear fender ZDM098K.

SWING ARM SPOOLS

MACHINED FROM BILLET ALUMINUM

DELRIN® PROTECTIVE RING | FIVE COLORS AVAILABLE



Brand	Model	Year	Thread	■	■	■	■	■
APRILIA®	All	All	M6x35	SC010A	SC010B	SC010G	SC010R	SC010U
BMW®	S1000 RR	All	M8x35	SC020A	SC020B	SC020G	SC020R	SC020U
BMW®	S1000 R	14 -	M8x35	SC020A	SC020B	SC020G	SC020R	SC020U
DUCATI®	899 PANIGALE	13 -	M6x35	SC010A	SC010B	SC010G	SC010R	SC010U
DUCATI®	MONSTER 821	14 -	M6x35	SC010A	SC010B	SC010G	SC010R	SC010U
DUCATI®	Other models	All	M8x35	SC020A	SC020B	SC020G	SC020R	SC020U
HONDA®	All	All	M8x35	SC020A	SC020B	SC020G	SC020R	SC020U
KAWASAKI®	Z800	13 -	M8x35	SC020A	SC020B	SC020G	SC020R	SC020U
KAWASAKI®	Z1000 / Z1000SX	14 -	M8x35	SC020A	SC020B	SC020G	SC020R	SC020U
KAWASAKI®	NINJA 600 ZX-6R	13 -	M8x35	SC020A	SC020B	SC020G	SC020R	SC020U
KAWASAKI®	Other models	All	M10x1,25x30	SC030A	SC030B	SC030G	SC030R	SC030U
KTM®	All	All	M8x35	SC020A	SC020B	SC020G	SC020R	SC020U
SUZUKI®	All	All	M8x35	SC020A	SC020B	SC020G	SC020R	SC020U
TRIUMPH®	DAYTONA 675	09 -	M8x35	SC020A	SC020B	SC020G	SC020R	SC020U
TRIUMPH®	STREET TRIPLE RX	15 -	M8x40	SC021A	SC021B	SC021G	SC021R	SC021U
TRIUMPH®	STREET TRIPLE / R	13 -	M8x35	SC020A	SC020B	SC020G	SC020R	SC020U
TRIUMPH®	STREET TRIPLE / R	07 - 12	M6x35	SC010A	SC010B	SC010G	SC010R	SC010U
TRIUMPH®	Other models	All	M6x35	SC010A	SC010B	SC010G	SC010R	SC010U
YAMAHA®	All	All	M6x35	SC010A	SC010B	SC010G	SC010R	SC010U

In the table above there are the most common bike models. In each case, before ordering, please, check the dimensions of the original product (OEM).



Please check availability in your area (see at pg. 288).

Code

RPL001B

BMW® R nineT





Headlight fairing (Aluminium)



Model	Year	Type	■	■
R nineT	14 -	Aluminium	ZBW042A	ZBW042B



Clip-on bar set



Model	Year	■
R nineT	14 -	MA050B



Handlebar top clamp set



Model	Year	■
R nineT	14 -	AZ452A



Triple clamp hole cover kit

Model	Year	■
R nineT	14 -	ZBW059A



Fluid tank cap

Model	Year	■	■	■	Position
R nineT	14 -	TP034A	TP034B	TP034U	Brake
R nineT	14 -	TP035A	TP035B	TP035U	Clutch



Crossbar for OEM handlebar

Model	Year	■
R nineT	14 -	MA109B



Engine cover

Model	Year	<input type="checkbox"/>	<input checked="" type="checkbox"/>
R nineT	14 -	ZBW045A	ZBW045B



Gas tank cap

Model	Year	<input type="checkbox"/>	<input checked="" type="checkbox"/>
R nineT	14 -	TF051A	TF051B



Front fender

Model	Year	<input type="checkbox"/>	<input checked="" type="checkbox"/>
R nineT	14 -	ZBW051A	ZBW051B



Rear fender for undertail

Model	Year	<input type="checkbox"/>	<input checked="" type="checkbox"/>
R nineT	14 -	ZBW058A	ZBW058B



Swing arm hole plug (right)

Model	Year	<input type="checkbox"/>	<input checked="" type="checkbox"/>	<input checked="" type="checkbox"/>
R nineT	14 -	ZBW034A	ZBW034B	ZBW034U

Frame hole Cap (left) / TELELEVER® Cap

Model	Year	<input type="checkbox"/>	<input checked="" type="checkbox"/>	<input checked="" type="checkbox"/>
R nineT	14 -	ZBW033A	ZBW033B	ZBW033U

Pivot cover

Model	Year	<input type="checkbox"/>	<input checked="" type="checkbox"/>	<input checked="" type="checkbox"/>
R nineT	14 -	ZBW026A	ZBW026B	ZBW026U



Rear Shock Preload Adjuster

Model	Year	<input type="checkbox"/>	<input checked="" type="checkbox"/>
R nineT	14 -	ZBW025A	ZBW025U



Rear set controls

Model	Year	■
R nineT	14 -	PE410B



Rider-passenger pegs "STREET"

Model	Year	■
R nineT	14 -	PE642B

To mount touring pegs adaptors PE795B (Rider) and PE786B (Passenger) are required. More info on page 136.



Intake tips / Velocity Stack

Model	Year	■
R nineT	14 - 15	ZBW054A



Exhaust tips

Model	Year	■
R nineT	14 -	ZBW056B



Head cover

Model	Year	■
R nineT	14 -	ZBW055AB



Head cover (Carbon)

Model	Year	■
R nineT	14 -	ZBW035K



USA VERSION
INCLUDED

License plate support



Model	Year	■
R nineT	14 -	PT709B

Our kit includes: license plate support, license plate support light, indicator light supports, undertail cover ZBW048, reflector kit, USA size plate holder.

Attention: to install the PT706/PT707/PT709 Rizoma Kit, please remove the OEM undertail cover, rear light and indicators. In accordance with the highway code, Rizoma recommends use of the "CLUB S" FR155 marker lights (on the license support plate or mounting them on the Rizoma undertail cover ZBW048), which integrate functions of the stop light, rear light and homologated marker lights.



USA VERSION
INCLUDED

License plate support kit with tail light



Model	Year	■
R nineT	14 -	PT711B

Our kit includes: license plate support, license plate support light, indicator light supports, undertail cover ZBW048, reflector kit, USA size plate holder.

Attention: To install the PT711 Rizoma Kit, please remove the OEM undertail cover, rear light and indicators. In accordance with the highway code, Rizoma supplies the license plate support integrated with the homologated Rizoma tail light. The kit includes adaptors for the repositioning of the OEM indicators, and also adaptors for installation of the Rizoma marker lights.





License plate support "SIDE ARM"

Model	Year	
R nineT	14 -	PT706B

Our kit includes: license plate support, license plate support light, indicator light supports, undertail cover ZBW048, reflector kit, USA size plate holder.

Attention: to install the PT706/PT707/PT709 Rizoma Kit, please remove the OEM undertail cover, rear light and indicators. In accordance with the highway code, Rizoma recommends use of the "CLUB S" FR155 marker lights (on the license support plate or mounting them on the Rizoma undertail cover ZBW048), which integrate functions of the stop light, rear light and homologated marker lights.



License plate support "OUTSIDE"

Model	Year	
R nineT	14 -	PT707B

Our kit includes: license plate support, license plate support light, indicator light supports, undertail cover ZBW048, reflector kit, USA size plate holder.

Attention: to install the PT706/PT707/PT709 Rizoma Kit, please remove the OEM undertail cover, rear light and indicators. In accordance with the highway code, Rizoma recommends use of the "CLUB S" FR155 marker lights (on the license support plate or mounting them on the Rizoma undertail cover ZBW048), which integrate functions of the stop light, rear light and homologated marker lights. The PT707 is not homologated for on road use where homologation is required.



Rear fender for license plate support "SIDE ARM"

Model	Year		
R nineT	14 -	ZBW053A	ZBW053B



Rear fender for license plate support "SIDE ARM" (Carbon)

Model	Year	
R nineT	14 -	ZDM098K

Fits only with License plate support Rizoma PT706.



Undertail cover

Model	Year	
R nineT	14 -	ZBW048B

The Rizoma underseat cover allows you to remove the rear light and the OEM license plate support.



BMW® S 1000 R





Rear set controls

Model	Year	Type	■
S 1000 R	14 -	EVO	PE409B ¹
S 1000 R	14 -	RRC	PER409B ²

¹ Reverse Gear Change Option: no
² Reverse Gear Change Option: included



USA VERSION
 INCLUDED



License plate support

Model	Year	■
S 1000 R	14 -	PT704B

Our kit includes: license plate support, license plate support light, indicator light supports, carbon undertail cover.



Headlight fairing (Polycarbonate)

Model	Year	■
S 1000 R	14 -	ZBW057B



Gas tank cap

Model	Year	■	■
S 1000 R	14 -	TF051A	TF051B



Engine guard - Right

Model	Year	■	■
S 1000 R	14 -	PM581B	PM581U



Engine guard - Left

Model	Year	■	■
S 1000 R	14 -	PM582B	PM582U

BMW® S 1000 R





Brake / Clutch levers "3D"



Model	Year	Type	Reg.	■	■	■
S 1000 R	14 -	Brake	✓	LBJ400A	LBJ400B	LBJ400G
S 1000 R	14 -	Clutch	✓	LCJ701A	LCJ701B	LCJ701G

Brake / Clutch levers "RRC"



Model	Year	Type	Reg.	■	■	■
S 1000 R	14 -	Brake	✓	LBR400A	LBR400B	LBR400G
S 1000 R	14 -	Clutch	✓	LCR702A	LCR702B	LCR702G



Sprocket Cover

Model	Year	■
S 1000 R	14 -	ZBW030A

ZBW030 compatible only with ABS models.



Camshaft Cover

Model	Year	■	■
S 1000 R	14 -	TP029B	TP029U



Axle Slider

Model	Year	■	Position
S 1000 R	14 -	PW701A	Front



Front OEM Marker Light Hole Caps (Carbon)

Model	Year	■
S 1000 R	14 -	FR321B



Rear Frame hole Cap Kit

Model	Year	■	■	■
S 1000 R	14 -	ZBW036A	ZBW036B	ZBW036U

BMW® R 1200 R





Head cover (Carbon)

Model	Year	■
R 1200 R / R CLASSIC	11 - 14	ZBW035K



Frame hole Cap / TELELEVER® Cap

Model	Year	■	■	■	Position
R 1200 R / R CLASSIC	06 - 14	ZBW033A	ZBW033B	ZBW033U	Left

Swing arm hole plug

Model	Year	■	■	■	Position
R 1200 R / R CLASSIC	06 - 14	ZBW034A	ZBW034B	ZBW034U	Right

Pivot cover

Model	Year	■	■	■
R 1200 R / R CLASSIC	06 -	ZBW026A	ZBW026B	ZBW026U



Fluid tank cap

Model	Year	■	■	■	Position
R 1200 R	15 -	TP034A	TP034B	TP034U	Brake
R 1200 R	15 -	TP035A	TP035B	TP035U	Clutch



Rear hub cover

Model	Year	■	■	■
R 1200 R	15 -	ZBW041A	ZBW041B	ZBW041U
R 1200 R	06 - 14	ZBW028A	ZBW028B	ZBW028U



OEM Handlebar caps

Model	Year	■	■	■	■	■
R 1200 R / R CLASSIC	06 - 14	MA510A	MA510B	MA510G	MA510R	MA510U



Engine oil filler cap

Model	Year	■
R 1200 R / R CLASSIC	06 - 15	TP030A

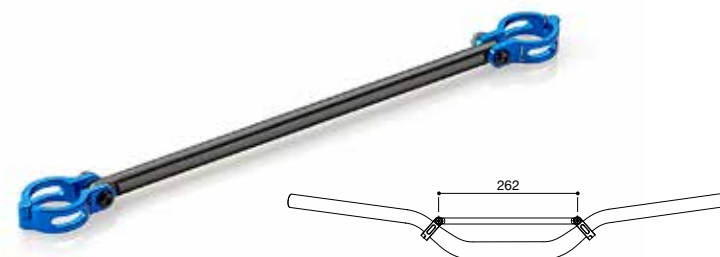

Crossbar

Model	Year	■	■
R 1200 R	15 -	ZBW047B	ZBW047U
R 1200 R CLASSIC	15 -	ZBW047B	ZBW047U

BMW® S 1000 RR





Rear set controls

Model	Year	Type	■
S 1000 RR	15 -	SPORT R	PER411B

Reverse Gear Change Option: included



Rear set controls

Model	Year	Type	■
S 1000 RR	09 - 14	EVO	PE409B ¹
S 1000 RR	09 - 14	RRC	PER409B ²

¹ Reverse Gear Change Option: no

² Reverse Gear Change Option: included

PM590A

PM580U



Engine guards

Model	Year	■	■
S 1000 RR	15 -	PM590A	PM590U
S 1000 RR	15 -	PM580A	PM580U
S 1000 RR	09 - 11	PM580A	PM580U



USA VERSION
INCLUDED



License plate support

Model	Year	■
S 1000 RR	09 -	PT704B

Our kit includes: license plate support, license plate support light, indicator light supports, reflector kit



Engine guard - Right

Model	Year	■	■
S 1000 RR	09 -	PM581B	PM581U



Engine guard - Left

Model	Year	■	■
S 1000 RR	09 -	PM582B	PM582U

BMW® S 1000 RR





Brake / Clutch levers "3D"

Model	Year	Type	Reg.	■	■	■
S 1000 RR	09 -	Brake	✓	LBJ400A	LBJ400B	LBJ400G
S 1000 RR	09 -	Clutch	✓	LCJ701A	LCJ701B	LCJ701G

Brake / Clutch levers "RRC"



Model	Year	Type	Reg.	■	■	■
S 1000 RR	09 -	Brake	✓	LBR400A	LBR400B	LBR400G
S 1000 RR	09 -	Clutch	✓	LCR702A	LCR702B	LCR702G



Front OEM Marker Light Hole Caps (Carbon)

Model	Year	■
S 1000 RR	09 -	FR321B



Front brake fluid tank cap

Model	Year	■	■	■
S 1000 RR	09 -	TP028A	TP028B	TP028U



Camshaft Cover

Model	Year	■	■
S 1000 RR	09 -	TP029B	TP029U



Sprocket Cover

Model	Year	■
S 1000 RR	09 -	ZBW030A

ZBW030 compatible only with ABS models.



Rear Frame hole Cap Kit

Model	Year	■	■	■
S 1000 RR	09 -	ZBW036A	ZBW036B	ZBW036U

BMW® S 1000 XR

016NEW



USA VERSION
INCLUDED



License plate support "FOX"

Model	Year	■
S 1000 XR	15 -	PT715B

Our kit includes: license plate support, license plate support light, indicator light supports, reflector kit



Pegs "RALLY"

Model	Year	■
S 1000 XR	15 -	PE640B

Rider Peg Adaptors PE798A
Passenger Peg Adaptors PE800A

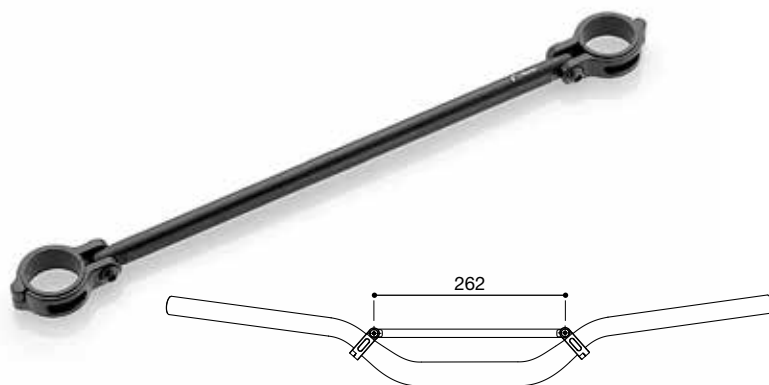

Crossbar

Model	Year	■
S 1000 XR	15 -	ZBW068B



Brake / Clutch levers "RRC"

Model	Year	Type	Reg.	■	■	■
S 1000 XR	15 -	Brake	✓	LBR706A	LBR706B	LBR706G
S 1000 XR	15 -	Clutch	✓	LCR706A	LCR706B	LCR706G



Pegs "TOURING"

Model	Year	■	■	■	■	■
S 1000 XR	15 -	PE622A	PE622B	PE622G	PE622R	PE622U

Rider Peg Adaptors PE798A
Passenger Peg Adaptors PE800A
More info on page 137.



Gas tank cap

Model	Year	■	■
S 1000 XR	15 -	TF053A	TF053B



BMW® S 1000 XR





Sprocket Cover

Model	Year	
S 1000 XR	15 -	ZBW030A

ZBW030 compatible only with ABS models.

Engine guards

Model	Year		
S 1000 XR	15 -	PM591A	PM591U



Engine guard - Right

Model	Year		
S 1000 XR	15 -	PM581B	PM581U

Engine guard - Left

Model	Year		
S 1000 XR	15 -	PM582B	PM582U



Axle Slider

Model	Year		Position
S 1000 XR	15 -	PW705A	Front

Camshaft Cover

Model	Year		
S 1000 XR	15 -	TP029B	TP029U

BMW® R 1200 GS

016UPDATE





Headlight Guard

Model	Year	■	■
R 1200 GS	15 -	ZBW064A	ZBW064B
R 1200 GS ADVENTURE	15 -	ZBW064A	ZBW064B

Highly practical, thanks to the fast and easy installation system and the protective pouch included in the kit. Attention, the Headlight Guard ZBW064 has been developed for Off-Road use.



Radiator Screen

Model	Year	■
R 1200 GS	15 -	ZBW065B
R 1200 GS ADVENTURE	15 -	ZBW065B

The Radiator Screens offered by Rizoma, are made of stainless steel, lightweight and functional. Protect the radiators from medium size debris while maintaining the cooling efficiency.



Skid Plate

Model	Year	■
R 1200 GS	15 -	ZBW060A
R 1200 GS ADVENTURE	15 -	ZBW060A

The kit is equipped with a light that switches on for 60 seconds when the side stand is lowered, illuminating the area below the bike for secure stand placement. EE007B included.



Side Stand Light

■
EE007B

The EE007 Kit includes: Light housing with LED light and the cables with an inline fuse required for a correct electric connection.

BMW® R 1200 GS





Heel Guard Kit

Model	Year	■
R 1200 GS	15 -	TT007A
R 1200 GS ADVENTURE	15 -	TT007A



Pegs "RALLY"

Model	Year	■
R 1200 GS	15 -	PE640B
R 1200 GS ADVENTURE	15 -	PE640B

Rider Peg Adaptors PE798A



Exhaust Guard

Model	Year	■
R 1200 GS	15 -	ZBW061A
R 1200 GS ADVENTURE	15 -	ZBW061A



Side Stand Base

Model	Year	■
R 1200 GS	15 -	ZBW063B

KIT ZBW062 (2x)

KIT ZBW062 (4x)

KIT ZBW062 (3x)



Frame hole caps Kit

Model	Year	■
R 1200 GS	13 -	ZBW062A
R 1200 GS ADVENTURE	14 -	ZBW062A

KIT ZBW044 (2x)

KIT ZBW044 (7x)



Frame hole caps Kit

Model	Year	■	■	■
R 1200 GS	13 -	ZBW044A	ZBW044B	ZBW044U
R 1200 GS ADVENTURE	14 -	ZBW044A	ZBW044B	ZBW044U

BMW® R 1200 GS





Head cover (Carbon)

Model	Year	■
R 1200 GS	10 - 12	ZBW035K
R 1200 GS ADVENTURE	10 - 13	ZBW035K



Rear hub cover

Model	Year	■	■	■
R 1200 GS	13 -	ZBW041A	ZBW041B	ZBW041U
R 1200 GS	04 - 12	ZBW028A	ZBW028B	ZBW028U
R 1200 GS ADV.	14 -	ZBW041A	ZBW041B	ZBW041U
R 1200 GS ADV.	10 - 13	ZBW028A	ZBW028B	ZBW028U



Fluid tank cap

Model	Year	■	■	■	Position
R 1200 GS	13 -	TP034A	TP034B	TP034U	Brake
R 1200 GS	13 -	TP035A	TP035B	TP035U	Clutch
R 1200 GS ADV.	14 -	TP034A	TP034B	TP034U	Brake
R 1200 GS ADV.	14 -	TP035A	TP035B	TP035U	Clutch



Gas tank cap

Model	Year	■	■
R 1200 GS	13 - 14	TF053A	TF053B
R 1200 GS	10 - 12	TF051A	TF051B



Swing arm hole plugs

Model	Year	■
R 1200 GS	13 -	ZBW043B
R 1200 GS ADVENTURE	14 -	ZBW043B



Engine oil filler cap

Model	Year	■
R 1200 GS	04 -	TP030A
R 1200 GS ADV.	10 -	TP030A

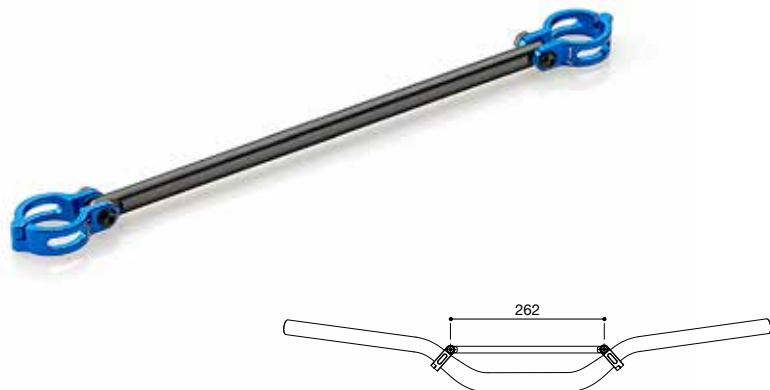

Crossbar

Model	Year	■	■
R 1200 GS	13 -	ZBW047B	ZBW047U
R 1200 GS ADVENTURE	14 -	ZBW047B	ZBW047U



Kit riser

Model	Year	■
R 1200 GS	13 -	AZ451T
R 1200 GS ADVENTURE	14 -	AZ451T

The Rizoma Riser Kit for BMW R1200 GS is made from the aluminum billet and characterized by a particular titan color. The product has been created to raise up (+45 mm) and drawn back (-22 mm) the handlebar, allowing the rider to maintain a more natural posture, increasing driving comfort and pleasure.



Pegs "TOURING"



Model	Year	■	■	■	■	■
R 1200 GS	04 -	PE622A	PE622B	PE622G	PE622R	PE622U
R 1200 GS ADV.	10 -	PE622A	PE622B	PE622G	PE622R	PE622U

Peg "TOURING" Adaptors

Model	Year	Rider	Passenger
R 1200 GS	13 -	PE798A	PE800A
R 1200 GS	04 - 12	PE793A	—
R 1200 GS ADVENTURE	14 -	PE798A	PE800A
R 1200 GS ADVENTURE	10 - 13	PE793A	—



Rear Shock Preload Adjuster

Model	Year	■
R 1200 GS	04 - 12	ZBW025A ZBW025U

Attention: ZBW025 doesn't fit with ESA System (electronic dampening). Except R 1200 GS Adventure.



Swing arm hole plug

Model	Year	■	■	■
R 1200 GS	04 - 12	ZBW034A	ZBW034B	ZBW034U
R 1200 GS ADV.	10 - 13	ZBW034A	ZBW034B	ZBW034U

Frame hole Cap (left) / TELELEVER® Cap

Model	Year	■	■	■
R 1200 GS	04 - 12	ZBW033A	ZBW033B	ZBW033U
R 1200 GS ADV.	10 - 13	ZBW033A	ZBW033B	ZBW033U

Pivot cover

Model	Year	■	■	■
R 1200 GS	04 -	ZBW026A	ZBW026B	ZBW026U
R 1200 GS ADV.	10 -	ZBW026A	ZBW026B	ZBW026U



Rear brake fluid tank cap

Model	Year	■	■	■	Ø (mm)	Thread
R 1200 GS	04 -	TP026A	TP026B	TP026U	49	M45x4
R 1200 GS ADV.	10 -	TP026A	TP026B	TP026U	49	M45x4

Front brake fluid tank cap

Model	Year	■	■	■	Ø (mm)	Thread
R 1200 GS	04 - 12	TP024A	TP024B	TP024U	62	M58x4
R 1200 GS ADV.	10 - 13	TP024A	TP024B	TP024U	62	M58x4

Clutch fluid tank cap

Model	Year	■	■	■	Ø (mm)	Thread
R 1200 GS	04 - 12	TP025A	TP025B	TP025U	46	M42x3
R 1200 GS ADV.	10 - 13	TP025A	TP025B	TP025U	46	M42x3



Brake / Clutch levers "3D"



Model	Year	Type	Reg.	■	■	■
R 1200 GS	13 -	Brake	✓	LBJ701A	LBJ701B	LBJ701G
R 1200 GS	13 -	Clutch	✓	LCJ705A	LCJ705B	LCJ705G
R 1200 GS	04 - 12	Brake	✓	LBJ700A	LBJ700B	LBJ700G
R 1200 GS	04 - 09	Clutch	✓	LCJ700A	LCJ700B	LCJ700G
R 1200 GS	10 - 12	Clutch	✓	LCJ703A	LCJ703B	LCJ703G
R 1200 GS ADV.	14 -	Brake	✓	LBJ701A	LBJ701B	LBJ701G
R 1200 GS ADV.	14 -	Clutch	✓	LCJ705A	LCJ705B	LCJ705G
R 1200 GS ADV.	10 - 13	Brake	✓	LBJ700A	LBJ700B	LBJ700G
R 1200 GS ADV.	10 - 13	Clutch	✓	LCJ703A	LCJ703B	LCJ703G

SCRAMBLER **DUCATI**[®]

016**NEW**





Headlight fairing

Model	Year	Type	■
SCRAMBLER	14 -	Aluminium	CF010A CF010B

Compatible with tapered handlebar in combination with AZ203 Riser Kit and the ZDM131 Headlight Fairing adaptor. It is also mountable with the MA051 Clip-On bars in combination with the ZDM128 Gauge Bracket and the ZDM131 Headlight Fairing adaptor.



Clip-on Bar Set

Model	Year	■	■
SCRAMBLER	14 -	MA051A	MA051B

Used with the MA051 Clip-On Bar Kit, the Rizoma Gauge Bracket allows the relocation the OEM instrumentation in a central position in relation to the triple clamps.



Headlight Fairing Adapter

Model	Year	■
SCRAMBLER	14 -	ZDM131B



Riser Kit (with Gauge Bracket)

Model	Year	■	■
SCRAMBLER	14 -	ZDM128A	ZDM128B

ZDM128 is compatible only in combination with the MA051 Rizoma Clip-On Bar Set and not with the OEM ones.



Brake / Clutch levers "3D"

Model	Year	Type	Reg.	■	■	■
SCRAMBLER	14 -	Brake	✓	LBJ502A	LBJ502B	LBJ502G
SCRAMBLER	14 -	Clutch	✓	LCJ503A	LCJ503B	LCJ503G

Brake / Clutch levers "RRC"



Model	Year	Type	Reg.	■	■	■
SCRAMBLER	14 -	Brake	✓	LBR503A	LBR503B	LBR503G
SCRAMBLER	14 -	Clutch	✓	LCR503A	LCR503B	LCR503G



Front brake fluid tank cap

Model	Year	■	■
SCRAMBLER	14 -	TP040A	TP040AB

SCRAMBLER **DUCATI**®





Timing belt Cover

Model	Year	■	■
SCRAMBLER	14 -	ZDM123A	ZDM123B



Airbox

Model	Year	■	■
SCRAMBLER	14 -	ZDM127A	ZDM127B



Front Fender

Model	Year	■	■
SCRAMBLER	14 -	ZDM129A	ZDM129B



Rear Fender

Model	Year	■	■
SCRAMBLER	14 -	ZDM132A	ZDM132B

The rear fender mounting involves the removal of the OEM tail light and indicators. We recommend FR155 Club S multifunction marker lights for the rear lighting. Not compatible with Ducati® Scrambler "Classic".



Cooler Covers (Right / Left)

Model	Year	■	■
SCRAMBLER	14 -	ZDM125A	ZDM125B



Fork tube guards

Model	Year	■	■
SCRAMBLER	14 -	ZDM134A	ZDM134B

SCRAMBLER **DUCATI**®





Rear set controls

Model	Year	■
SCRAMBLER	14 -	PE213B



Pegs "STREET"

Model	Year	■
SCRAMBLER	14 -	PE642B

To mount touring pegs adaptors PE711A (Rider / Passenger) are required (Pair). More info on page 136.

USA VERSION INCLUDED



License plate support

Model	Year	■
SCRAMBLER	14 -	PT526B

Our kit includes: license plate support, license plate support light, indicator light supports, reflector kit. Horizontal adjustment. The "FOX" Rizoma License Plate Support PT526B, allows the positioning of the license plate on the rear fender. Fits on Icon, Urban and Full Throttle Scrambler models.

USA VERSION INCLUDED



License plate support "OUTSIDE"

Model	Year	■
SCRAMBLER	14 -	PT527B

Our kit includes: license plate support, license plate support light, indicator light supports, reflector kit. Horizontal adjustment.



Sprocket Cover

Model	Year	■
SCRAMBLER	14 -	ZDM133A ZDM133B



Chain guard

Model	Year	■
SCRAMBLER	14 -	ZDM124A ZDM124B

SCRAMBLER **DUCATI**®





Riser (with Gauge Bracket)

Model	Year	■	■
SCRAMBLER	14 -	AZ203A	AZ203B

The Rizoma Riser Kit allows replacement of the OEM handlebar with a 1-1/8 inch diameter tapered handlebar, positioning the instrumentation centrally.



MA006 / MA009 1-1/8 inch Diameter Tapered Handlebars

See page 95



Engine guards

Model	Year	■	
SCRAMBLER	14 -	PM357A	



Axle Slider

Model	Year	■	Position
SCRAMBLER	14 -	PW200A	Front
SCRAMBLER	14 -	PW219A	Rear



Gas tank cap "Café Racer"

Model	Year	■	■
SCRAMBLER	14 -	TF142A	TF142B



Marker Light "CLUB S"

See page 62

Attention, in case of removal of the rear light and, therefore, the mounting of the Rizoma FR155 "CLUB S" indicators, for the correct functioning of the electrical system is necessary to use both the EE079 and EE115 cable kits.

DUCATI® MONSTER 1200





USA VERSION
INCLUDED



License plate support "SIDE ARM"

Model	Year	
MONSTER 1200	14 -	PT519B

Our kit includes: license plate support, license plate support light, indicator light supports, reflector kit. Compatible with Rizoma Carbon rear fender ZDM098K.



Under tail

Model	Year	
MONSTER 1200	14 -	ZDM118B



Timing belt Cover

Model	Year	Position		
MONSTER 1200	14 -	Vertical	ZDM119A	ZDM119B



Timing belt Cover

Model	Year	Position		
MONSTER 1200	14 -	Horizontal	ZDM120A	ZDM120B



Kit riser



Model	Year	
MONSTER 1200	14 -	AZ202B

Riser Kit AZ202B fits on OEM handlebar and Rizoma handlebar MA011 and MA015.
Attention: after installation of the MA011 / MA015 Rizoma handlebars, please, adjust the steering angle to avoid a possible contact of the handlebar on the tank.



Engine guards

Model	Year	
MONSTER 1200	14 -	PM354A

DUCATI® MONSTER 1200





Axle Slider

Model	Year	■	Position
MONSTER 1200	14 -	PW206A	Front



Rear hub cover with protection

Model	Year	■
MONSTER 1200	14 -	ZDM094A

Attention: Once the ZDM094 kit is installed, the rear hub inner diameter is reduced to 30 mm.



Water pump protection

Model	Year	■
MONSTER 1200	14 -	PM506A



Gas tank cap

Model	Year	■	■
MONSTER 1200	14 -	TF041A	TF041B



Brake / Clutch levers "3D"



Model	Year	Type	Reg.	■	■	■
MONSTER 1200	14 -	Brake	✓	LBJ500A	LBJ500B	LBJ500G
MONSTER 1200	14 -	Clutch	✓	LCJ500A	LCJ500B	LCJ500G



Brake / Clutch levers "RRC"



Model	Year	Type	Reg.	■	■	■
MONSTER 1200	14 -	Brake	✓	LBR500A	LBR500B	LBR500G
MONSTER 1200	14 -	Clutch	✓	LCR500A	LCR500B	LCR500G

DUCATI® MONSTER 821





USA VERSION
INCLUDED



License plate support

Model	Year	■
MONSTER 821	14 -	PT517B

Our kit includes: license plate support, license plate support light, indicator light supports, reflector kit.



Brake / Clutch levers "RRC"

Model	Year	Type	Reg.	■	■	■
MONSTER 821	14 -	Brake	✓	LBR503A	LBR503B	LBR503G
MONSTER 821	14 -	Clutch	✓	LCR503A	LCR503B	LCR503G



ZDM119A



ZDM120A

Timing belt Cover

Model	Year	Position	■	■
MONSTER 821	14 -	Vertical	ZDM119A	ZDM119B
MONSTER 821	14 -	Horizontal	ZDM120A	ZDM120B



Water pump protection

Model	Year	■
MONSTER 821	14 -	PM506A



Kit riser

Model	Year	■
MONSTER 821	14 -	AZ202B

The Riser Kit is compatible with the OEM handlebar and with the MA011 / MA015 Rizoma handlebars. Attention: after installation of the MA011 / MA015 Rizoma handlebars, please, adjust the steering angle to avoid a possible contact of the handlebar on the tank.



Engine guards

Model	Year	■
MONSTER 821	14 -	PM354A

DUCATI® MONSTER





Rear set controls "REV"

Model	Year	■
696	08 -	PE209B
796	10 -	PE209B
1100 EVO	11 -	PE209B
1100 / 1100 S	09 - 10	PE209B

Vertical Adjustment: 10 - 20 mm
 Horizontal Adjustment: 12,5 - 25 mm
 Reverse Gear Change Option: included



USA VERSION
INCLUDED



License plate support "SIDE ARM"

Model	Year	■
796	10 -	PT512B
1100 EVO	11 -	PT512B
1100 / 1100 S	09 - 10	PT512B

Our kit includes: license plate support, license plate support light, indicator light supports, reflector kit.



USA VERSION
INCLUDED



License plate support

Model	Year	■
696	08 -	PT511B
796	10 -	PT511B
1100 EVO	11 -	PT511B
1100 / 1100 S	09 - 10	PT511B

Our kit includes: license plate support, license plate support light, indicator light supports, reflector kit.



Parafango in Carbon

Model	Year	■
796	10 -	ZDM098K
1100 EVO	11 -	ZDM098K
1100 / 1100 S	09 - 10	ZDM098K

Compatible only with Rizoma license plate support PT512.



ZDM088A

Timing belt Cover

Model	Year	■	■
696	08 -	ZDM088A	ZDM088B
796	10 -	ZDM088A	ZDM088B
1100 / 1100 S	09 - 10	ZDM019A	ZDM019B

DUCATI® MONSTER





Passenger Pegs

Model	Year	■
696	08 -	PE576B
796	10 -	PE576B
1100 / 1100 S	09 - 10	PE576B



Engine guards

Model	Year	■
696 / 796	08 -	PM501B
1100 EVO	11 -	PM501B
1100 / 1100 S	09 - 10	PM501B



Brake / Clutch levers "3D"



Model	Year	Type	Reg.	■	■	■
696 / 796	08 -	Brake	✓	LBJ502A	LBJ502B	LBJ502G
696 / 796	08 -	Clutch	✓	LCJ502A	LCJ502B	LCJ502G
1100 EVO	11 -	Brake	✓	LBJ500A	LBJ500B	LBJ500G
1100 EVO	11 -	Clutch	✓	LCJ500A	LCJ500B	LCJ500G
1100 / 1100 S	09 -	Brake	✓	LBJ500A	LBJ500B	LBJ500G
1100 / 1100 S	09 -	Clutch	✓	LCJ500A	LCJ500B	LCJ500G



Cable cover

Model	Year	■
796	10 -	ZDM081A
1100 EVO	11 -	ZDM081A
1100 / 1100 S	09 - 10	ZDM081A



Engine guards

Model	Year	■
696 / 796	08 -	PM351B
1100 EVO	11 -	PM351B
1100 / 1100 S	09 - 10	PM351B



Brake / Clutch levers "RRC"



Model	Year	Type	Reg.	■	■	■
1100 EVO	11 -	Brake	✓	LBR500A	LBR500B	LBR500G
1100 EVO	11 -	Clutch	✓	LCR500A	LCR500B	LCR500G
1100 / 1100 S	09 -	Brake	✓	LBR500A	LBR500B	LBR500G
1100 / 1100 S	09 -	Clutch	✓	LCR500A	LCR500B	LCR500G

DUCATI® DIAVEL





Rear set controls "REV"

Model	Year	■
DIAVEL	10 -	PE212B

Vertical Adjustment: 16 mm
 Horizontal Adjustment: 16 mm
 Reverse Gear Change Option: No



EU VERSION
INCLUDED



License plate support "OUTSIDE"

Model	Year	■
DIAVEL	10 -	PT510B



USA VERSION
INCLUDED



License plate support "SIDE ARM"

Model	Year	■
DIAVEL	10 -	PT509B

Our kit includes: license plate support, license plate support light, indicator light supports, reflector kit.



Parafango in Carbon

Model	Year	■
DIAVEL	10 -	ZDM098K

Compatible only with Rizoma license plate support PT509.



Rear Shock Preload Adjuster

Model	Year	■	■	■
DIAVEL	10 -	ZDM095A	ZDM095B	ZDM095R



Headlight fairing

Model	Year		■	■	■
DIAVEL	10 -13	Aluminium	ZDM100A	ZDM100B	-
DIAVEL	10 -13	Carbon	-	-	ZDM100K

To mount the Rizoma ZDM100 the adapter is required.

ZDM110B: Single Position Headlight Fairing Adapter for use with OEM handlebars.

ZDM111B: Adjustable Headlight Fairing Adapter for Rizoma handlebar MA207.



MA207A



Handlebar "Style & Comfort"

Model	Year	■	■
DIAVEL	10 -	MA207A	MA207B



Clutch cover protection

Model	Year	■
DIAVEL	10 -	ZDM097A



Headlight fairing

Model	Year	■	■
DIAVEL	14 -	ZDM105A	ZDM105B

Attention: to install the Rizoma ZDM105 headlight fairing (or the OEM Headlight fairing) with the Rizoma MA207 handlebar (or the OEM Headlight fairing), the ZDM107B adapter is required. No adapter is required for use with the OEM handlebars.



Front brake fluid tank cap

Model	Year	■	■
DIAVEL	10 -	ZDM103A	ZDM103B

Clutch brake fluid tank cap

Model	Year	■	■
DIAVEL	10 -	ZDM102A	ZDM102B



Fairing guards (slider)

Model	Year	■
DIAVEL	10 -	PM505B



Sprocket Cover

Model	Year	
DIANEL	10 -	ZDM096A



Water pump protection

Model	Year	
DIANEL	10 -	PM506A



Rear hub cover with protection

Model	Year	
DIANEL	10 -	ZDM094A

Attention: Once the ZDM094 kit is installed, the rear hub inner diameter is reduced to 30 mm.



Frame hole cap kit

Model	Year			
DIANEL	10 -	ZDM112A	ZDM112B	ZDM112R



Brake / Clutch levers "3D"



Model	Year	Type	Reg.			
DIANEL	10 -	Brake	✓	LBJ500A	LBJ500B	LBJ500G
DIANEL	10 -	Clutch	✓	LCJ500A	LCJ500B	LCJ500G



Brake / Clutch levers "RRC"



Model	Year	Type	Reg.			
DIANEL	10 -	Brake	✓	LBR500A	LBR500B	LBR500G
DIANEL	10 -	Clutch	✓	LCR500A	LCR500B	LCR500G

DUCATI® HYPERMOTARD / HYPERSTRADA





USA VERSION
INCLUDED



License plate support "SIDE ARM"

Model	Year	■
HYPERMOTARD / HYPERSTRADA	13 -	PT516B



USA VERSION
INCLUDED



License plate support

Model	Year	■
HYPERMOTARD / HYPERSTRADA	13 -	PT515B

Our kit includes: license plate support, license plate support light, indicator light supports, reflector kit. Horizontal adjustment.



Carbon rear fender

Model	Year	■
HYPERMOTARD / HYPERSTRADA	13 -	ZDM098K

Compatible only with Rizoma license plate support PT516B.



Brake / Clutch levers "RRC"

Model	Year	Type	Reg.	■	■	■
HYPERMOTARD	13 -	Brake	✓	LBR503A	LBR503B	LBR503G
HYPERMOTARD	13 -	Clutch	✓	LCR503A	LCR503B	LCR503G
HYPERSTRADA	13 -	Brake	✓	LBR503A	LBR503B	LBR503G
HYPERSTRADA	13 -	Clutch	✓	LCR503A	LCR503B	LCR503G



"TOURING" Pegs

Model	Year	■	■	■	■	■
HYPERMOTARD	13 -	PE622A	PE622B	PE622G	PE622R	PE622U
HYPERSTRADA	13 -	PE622A	PE622B	PE622G	PE622R	PE622U

To mount touring pegs adaptors PE713A are required (Pair). More info on page 137.



Axle Slider

Model	Year	■	Position
HYPERMOTARD / HYPERSTRADA	13 -	PW209A	Front

DUCATI® HYPERMOTARD / HYPERSTRADA





Rear hub cover with protection

Model	Year	■
HYPERMOTARD / HYPERSTRADA	13 -	ZDM099A



Rear hub cover with protection

Model	Year	■
HYPERMOTARD / HYPERSTRADA	13 -	PW204A



Water pump protection

Model	Year	■	■
HYPERMOTARD / HYPERSTRADA	13 -	PM353A	PM353B



Water pump protection

Model	Year	■
HYPERMOTARD / HYPERSTRADA	13 -	PM503A



Engine guards

Model	Year	■
HYPERMOTARD / HYPERSTRADA	13 -	PM508B



Engine guards

Model	Year	■
HYPERMOTARD / HYPERSTRADA	13 -	PM509B

DUCATI® MULTISTRADA





USA VERSION
INCLUDED



License plate support

Model	Year	■
1200 / 1200 S	10 - 14	PT508B

Our kit includes: license plate support, license plate support light, indicator light supports, reflector kit. PT508B compatible with OEM Saddlebag.



ZDM091A

Timing belt Cover

Model	Year	■	■
1000 / 1000 S	03 - 06	ZDM019A	ZDM019B
1100 / 1100 S	06 - 09	ZDM019A	ZDM019B
1200 / 1200 S	10 -	ZDM091A	ZDM091B



Engine guards

Model	Year	■
1200 / 1200 S	13 - 14	PM507A



Engine guards

Model	Year	■
1200 / 1200 S	10 - 12	PM504B



Water pump protection

Model	Year	■	■
1200 / 1200 S	13 -	PM353A	PM353B



Water pump protection

Model	Year	■
1200 / 1200 S	10 -	PM503A

DUCATI® MULTISTRADA





Axle Slider

Model	Year		Position
1200 / 1200 S	10 -	PW209A	Front



Rear hub cover with protection

Model	Year	
1200 / 1200 S	10 -	ZDM094A

Attention: Once the ZDM094 kit is installed, the rear hub inner diameter is reduced to 30 mm.



Brake / Clutch levers "3D"



Model	Year	Type	Reg.			
620	05 - 07	Brake	✓	LBJ502A	LBJ502B	LBJ502G
620	05 - 07	Clutch	✓	LCJ502A	LCJ502B	LCJ502G
1200 / 1200 S	10 -	Brake	✓	LBJ500A	LBJ500B	LBJ500G
1200 / 1200 S	10 -	Clutch	✓	LCJ500A	LCJ500B	LCJ500G



Rear Shock Preload Adjuster

Model	Year			
1200	10 - 14	ZDM095A	ZDM095B	ZDM095R



Pegs "TOURING"



Model	Year					
1200 / 1200 S	10 -	PE622A	PE622B	PE622G	PE622R	PE622U

To mount touring pegs adaptors PE713A are required - (Pair).
More info on page 137.



Water pump protection

Model	Year	
1200 / 1200 S	15 -	PM506A

DUCATI® 1299 / 1199 / 899 PANIGALE





Rear set controls "RRC"

Model	Year	■
899	14 -	PER214B
1199 / 1199 S	12 -	PER214B

PER214 mounts also with the quickshifter models. The PER214 rearset can be installed for reverse shifting using the Ducati accessory reverse quick shift lever.



USA VERSION
INCLUDED



License plate support

Model	Year	■
1299 / 1299 S	15 -	PT514B
899	14 -	PT514B
1199 / 1199 S	12 -	PT514B

Our kit includes: license plate support, license plate support light, indicator light supports, reflector kit.



PW218A



PW208A

Axle Slider

Model	Year	■	Position
1299 S	15 -	PW208A	Front
899	14 -	PW208A	Front
899	14 -	PW218A	Rear



Rear hub cover with protection

Model	Year	■
1299 / 1299 S	15 -	ZDM094A
1199 / 1199 S	12 -	ZDM094A

Attention: Once the ZDM094 kit is installed, the rear hub inner diameter is reduced to 30 mm.



Gas tank cap

Model	Year	■	■
1299 / 1299 S	15 -	TF042A	TF042B
899	14 -	TF042A	TF042B
1199 / 1199 S	12 -	TF042A	TF042B



Clutch cover protection

Model	Year	■
1299 / 1299 S	15 -	ZDM113B
1199 / 1199 S	12 -	ZDM113B

DUCATI® 1299 / 1199 / 899 PANIGALE

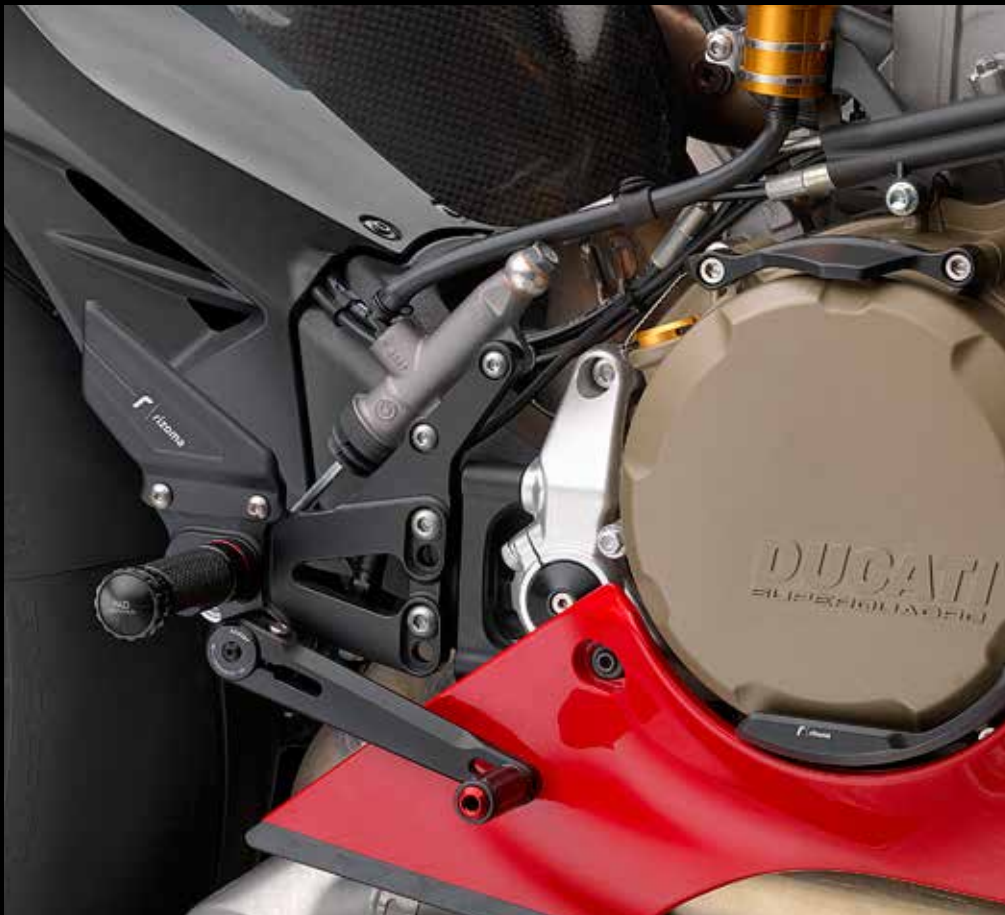



Brake / Clutch levers "3D"



Model	Year	Type	Reg.	■	■	■
1299	15 -	Brake	✓	LBJ500A	LBJ500B	LBJ500G
1299	15 -	Clutch	✓	LCJ500A	LCJ500B	LCJ500G
899	14 -	Brake	✓	LBJ500A	LBJ500B	LBJ500G
899	14 -	Clutch	✓	LCJ500A	LCJ500B	LCJ500G
1199	12 -	Brake	✓	LBJ500A	LBJ500B	LBJ500G
1199	12 -	Clutch	✓	LCJ500A	LCJ500B	LCJ500G

Clutch cover protection

Model	Year	■
1299 / 1299 S	15 -	ZDM114A
899	14 -	ZDM114A



Brake / Clutch levers "RRC"



Model	Year	Type	Reg.	■	■	■
1299	15 -	Brake	✓	LBR500A	LBR500B	LBR500G
1299	15 -	Clutch	✓	LCR500A	LCR500B	LCR500G
899	14 -	Brake	✓	LBR500A	LBR500B	LBR500G
899	14 -	Clutch	✓	LCR500A	LCR500B	LCR500G
1199	12 -	Brake	✓	LBR500A	LBR500B	LBR500G
1199	12 -	Clutch	✓	LCR500A	LCR500B	LCR500G



Frame hole caps Kit (Ø 24/30 mm)

Model	Year	■	■	■
1299 S	15 -	ZDM115A	ZDM115B	ZDM115R
899	14 -	ZDM115A	ZDM115B	ZDM115R
1199 / 1199 S	12 -	ZDM115A	ZDM115B	ZDM115R



Fluid tank bracket

Model	Year	■
1299 / 1299 S	15 -	CT453B
899	14 -	CT453B
1199 / 1199 S	12 -	CT453B

Fluid tanks: see page 100 -105.

DUCATI® MONSTER OLD SERIES





Clutch Cover

Model	Year	■	■	■
900	93 - 02	ZDM026A	ZDM026B	ZDM026G
1000	03 - 05	ZDM026A	ZDM026B	ZDM026G
S4 / S4R	02 - 07	ZDM026A	ZDM026B	ZDM026G

The many versions and colors of our clutch covers can be installed on any dry clutch Ducati motorcycle. Models excluded are the 600, 620, 696, 750, 796, 800, 848, 1199, 1200.



Clutch Cover

Model	Year	■	■	■
900	93 - 02	ZDM025A	ZDM025B	ZDM025G
1000 / 1000 S	03 - 05	ZDM025A	ZDM025B	ZDM025G
S4 / S4R	02 - 07	ZDM025A	ZDM025B	ZDM025G

The many versions and colors of our clutch covers can be installed on any dry clutch Ducati motorcycle. Models excluded are the 600, 620, 696, 750, 796, 800, 848, 1199, 1200.



Pressure plate

Model	Year	■	■	■
900	93 - 02	ZDM085B	ZDM085G	ZDM085R
1000	03 - 05	ZDM085B	ZDM085G	ZDM085R
S4 / S4R	02 - 07	ZDM085B	ZDM085G	ZDM085R

The many versions and colors of our clutch covers can be installed on any dry clutch Ducati motorcycle. Models excluded are the 600, 620, 696, 750, 796, 800, 848, 1199, 1200.



Pressure plate

Model	Year	■	■	■
900	93 - 02	ZDM036B	ZDM036G	ZDM036R
1000	03 - 05	ZDM036B	ZDM036G	ZDM036R
S4 / S4R	02 - 07	ZDM036B	ZDM036G	ZDM036R

The many versions and colors of our clutch covers can be installed on any dry clutch Ducati motorcycle. Models excluded are the 600, 620, 696, 750, 796, 800, 848, 1199, 1200.



Clutch Cover

Model	Year	■
900	93 - 02	ZDM024B
1000 / 1000 S	03 - 05	ZDM024B
S4 / S4R	02 - 07	ZDM024B

The many versions and colors of our clutch covers can be installed on any dry clutch Ducati motorcycle. Models excluded are the 600, 620, 696, 750, 796, 800, 848, 1199, 1200.



Timing belt cover

Model	Year	■	■
1000 / 1000 s	03 - 05	ZDM019A	ZDM019B
S2R 1000	05 - 07	ZDM019A	ZDM019B



Rear set controls "REV"

Model	Year	■
600 / 620 / 695	01 - 08	PE201B
750	01 - 02	PE201B
800	03 - 05	PE201B
900	01 - 02	PE201B
1000	03 - 05	PE201B
S4	02 - 03	PE201B

Reverse Gear Change Option: no



Rear set controls "REV"

Model	Year	■
S2 R	04 - 07	PE202B
S4 R / S4 Rs Testastretta	03 - 08	PE202B

Reverse Gear Change Option: no



Passenger Pegs

Model	Year	■
600 / 620	01 - 06	PE568B
750	01 - 02	PE568B
800	03 - 05	PE568B
900	93 - 02	PE568B
1000	03 - 05	PE568B
S4	02 - 03	PE568B

PE568B - Passenger pegs for rear set control kit PE201B (Except Models S2R / S4R / S4RS T.S.)



USA VERSION
INCLUDED



License plate support

Model	Year	■
MONSTER 600	94 - 02	PT500B
MONSTER 620	02 - 06	PT500B
MONSTER 695	06 - 08	PT500B
MONSTER 750	96 - 02	PT500B
MONSTER 800	03 - 05	PT500B
MONSTER 900	93 - 02	PT500B
MONSTER 1000	03 - 05	PT500B
MONSTER 1000 S	03 - 05	PT511B
MONSTER S2 R	04 - 07	PT500B
MONSTER S2R 1000	05 - 07	PT500B
MONSTER S4	02 - 03	PT500B
MONSTER S4R	03 - 07	PT500B

Our kit includes: license plate support, license plate support light, indicator light supports, reflector kit.



Engine guards

Model	Year	■
MONSTER 1000 / 1000 S	03 - 05	PM501B



Triple tree kit

Model	Year	■
MONSTER 620	02 - 06	PA202D
MONSTER 800	03 - 05	PA202D
MONSTER 1000	03 - 05	PA202D
MONSTER S2 R	04 - 07	PA202D
MONSTER S4	02 - 03	PA202D
MONSTER S4R	03 - 07	PA202D



Engine guards

Model	Year	■
MONSTER 1000 S	03 - 05	PM351B

HONDA® CB 1000 R





USA VERSION
INCLUDED



License plate support

Model	Year	■
CB 1000 R	08 -	PT103B

Our kit includes: license plate support, license plate support light, indicator light supports, reflector kit.



Engine guards

Model	Year	■
CB 1000 R	10 -	PM114A



USA VERSION
INCLUDED



License plate support "SIDE ARM"

Model	Year	■
CB 1000 R	11 -	PT107B
CB 1000 R ABS	11 -	PT107B

Our kit includes: license plate support, license plate support light, indicator light supports, reflector kit.



Parafango in Carbon

Model	Year	■
CB 1000 R	11 -	ZDM098K

Compatible only with Rizoma license plate support PT107B.



Rear set controls "REV"

Model	Year	■
CB 1000 R	08 -	PE080B

Vertical Adjustment : 10 - 20 mm
Horizontal Adjustment 10 - 20 mm
Reverse Gear Change Option NO
Buy fluid tanks CT025 separately



Engine guards

Model	Year	■	Position
CB 1000 R	08 -	PM521A	Left

HONDA® CB 1000 R





Engine guards

Model	Year	■
CB 1000 R	08 -	PM101B



Axle Slider

Model	Year	■	Position
CB 1000 R	08 -	PW064A	Front



Brake / Clutch levers "3D"



Model	Year	Type	Reg.	■	■	■
CB 1000 R	08 -	Brake	✓	LBJ103A	LBJ103B	LBJ103G
CB 1000 R	08 -	Clutch	✓	LCJ101A	LCJ101B	LCJ101G



Crankcase Guard

Model	Year	■	■
CB 1000 R	08 - 14	ZHH052A	ZHH052B



Front OEM Marker Light Hole Caps (Carbon)

Model	Year	■
CB 1000 R	15 -	FR322B



Rear Frame hole Cap Kit

Model	Year	■	■	■
CB 1000 R	15 -	ZBW036A	ZBW036B	ZBW036U



Brake fluid tank



Model	Year	■	■	■	■	■	ø (mm)	H (mm)
CB 1000 R	08 -	CT028A	CT028B	CT028G	CT028R	CT028U	49	48

Clutch fluid tank



Model	Year	■	■	■	■	■	ø (mm)	H (mm)
CB 1000 R	08 -	CT029A	CT029B	CT029G	CT029R	CT029U	40	44

HONDA® CB 650 F



USA VERSION
INCLUDED



License plate support

Model	Year	■
CB 650 F	15 -	PT111B

Our kit includes: license plate support, license plate support light, indicator light supports, reflector kit.



Engine guards

Model	Year	■
CB 650 F	15 -	PM116A



Crankcase Guard

Model	Year	■	■
CB 650 F	15 -	ZHH052A	ZHH052B



Brake / Clutch levers "RRC"

Model	Year	Type	Reg.	■	■	■
CB 650 F	15 -	Brake	✓	LBR100A	LBR100B	LBR100G
CB 650 F	15 -	Clutch	✓	LCR102A	LCR102B	LCR102G



Axle Slider

Model	Year	■	Position
CB 650 F	15 -	PW064A	Front



PROGUARD SYSTEM®

More info on pages 66 - 69

HONDA® CBR 1000 RR





Rear set controls



Model	Year	Type	■
CBR 1000 RR	10 -	EVO	PE082B
CBR 1000 RR C- ABS	09 -	EVO	PE082B
CBR 1000 RR	08 -	RRC	PER082B

Reverse Gear Change Option: included



Axle Slider

Model	Year	■	Position
CBR 1000 RR	10 -	PW062A	Front
CBR 1000 RR	10 -	PW063A	Rear



USA VERSION
INCLUDED



License plate support

Model	Year	■
CBR 1000 RR	10 -	PT104B
CBR 1000 RR C- ABS	10 -	PT104B
CBR 1000 RR	04 - 07	PT100B

Our kit includes: license plate support, license plate support light, indicator light supports, reflector kit.



Engine oil filler cap



Model	Year	■	■	■	■	■
CBR 1000 RR	All	TP008A	TP008B	TP008G	TP008R	TP008U



Gas tank cap



Model	Year	■	■
CBR 1000 RR	All	TF020A	TF020B

Attention: TF020 not compatible with SP model.

HONDA® CBR 600 RR





Rear set controls "RRC"

Model	Year	■
CBR 600 RR / C-ABS	13 -	PER083B
CBR 600 RR	07 - 12	PER081B

Reverse Gear Change Option: it doesn't fit with ABS models.



USA VERSION
INCLUDED



License plate support

Model	Year	■
CBR 600 RR / C-ABS	13 -	PT109B
CBR 600 RR	03 - 06	PT100B
CBR 600 RR / C-ABS	07 - 12	PT101B ¹

Our kit includes: license plate support, license plate support light, indicator light supports, reflector kit.

¹ Rear Light included



Brake / Clutch levers "3D"

Model	Year	Type	Reg.	■	■	■
CBR 600 RR / C-ABS	07 -	Brake	✓	LBJ104A	LBJ104B	LBJ104G
CBR 600 RR / C-ABS	07 -	Clutch	—	LCJ200A	LCJ200B	LCJ200G
CBR 600 RR / C-ABS	07 -	Clutch	✓	LCJ201A	LCJ201B	LCJ201G



Brake / Clutch levers "RRC"

Model	Year	Type	Reg.	■	■	■
CBR 600 RR / C-ABS	07 -	Brake	✓	LBR104A	LBR104B	LBR104G
CBR 600 RR / C-ABS	07 -	Clutch	✓	LCR201A	LCR201B	LCR201G



Crankcase Guard

Model	Year	■	■
CBR 600 RR	03 - 08	ZHH052A	ZHH052B



PW064A

Axle Slider

Model	Year	■	Position
CBR 600 RR / C-ABS	09 -	PW064A	Front
CBR 600 RR / C-ABS	09 -	PW061A	Rear

KAWASAKI® Z1000





Rear set controls "EVO"

Model	Year	■
Z1000	10 -	PE315B
Z1000SX	11 -	PE315B

Reverse Gear Change Option: no



Headlight fairing (Polycarbonate)

Model	Year	■
Z1000	14 -	ZKW030B



Engine guards

Model	Year	■
Z1000	14 -	PM320A



Engine guards

Model	Year	■
Z1000	10 -	PM315A



Engine guards

Model	Year	■
Z1000	10 - 13	PM316B
Z1000	07 - 09	PM312B



Engine guards

Model	Year	■
Z1000	03 - 06	PM305B

KAWASAKI® Z1000



Engine guard

Model	Year	■	Position
Z1000	14 -	PM322B	Left



Engine guard

Model	Year	■	Position
Z1000	10 -	PM321B	Right



Brake / Clutch levers "3D"



Model	Year	Type	Reg.	■	■	■
Z1000	03 - 06	Clutch	✓	LCJ302A	LCJ302B	LCJ302G
Z1000	03 - 06	Clutch	—	LCJ301A	LCJ301B	LCJ301G
Z1000 / Z1000SX	07 -	Brake	✓	LBJ301A	LBJ301B	LBJ301G
Z1000 / Z1000SX	07 -	Clutch	✓	LCJ302A	LCJ302B	LCJ302G
Z1000 / Z1000SX	07 -	Clutch	—	LCJ301A	LCJ301B	LCJ301G



Brake / Clutch levers "RRC"



Model	Year	Type	Reg.	■	■	■
Z1000 / Z1000SX	07 -	Brake	✓	LBR301A	LBR301B	LBR301G
Z1000 / Z1000SX	07 -	Clutch	✓	LCR301A	LCR301B	LCR301G



Axle Slider



Model	Year	■	Position
Z1000	10 - 13	PW305A	Front
Z1000	14 -	PW308A	Front
Z1000SX	14 -	PW305A	Front



Frame Hole Cap

Model	Year	■
Z1000	10 - 13	ZKW013B
Z1000SX	10 -	ZKW013B



USA VERSION
INCLUDED



License plate support

Model	Year	■
Z1000	14 -	PT315B

Our kit includes: license plate support, license plate support light, indicator light supports, reflector kit.



Rizoma graphic Kit

Model	Year	■
Z1000 / Z1000SX	14 -	ZKW031B



OEM Handlebar caps

Model	Year	■	■	■	■	■
Z1000SX	10 -	MA510A	MA510B	MA510G	MA510R	MA510U
Z1000	03 -	MA510A	MA510B	MA510G	MA510R	MA510U



USA VERSION
INCLUDED



License plate support

Model	Year	■
Z1000	10 - 13	PT310B
Z1000	07 - 09	PT306B
Z1000SX	11 -	PT310B

Our kit includes: license plate support, license plate support light, indicator light supports, reflector kit.



Gas tank cap

Model	Year	■	■
Z1000	10 -	TF010A	TF010B
Z1000SX	11 -	TF010A	TF010B



Brake fluid tank

Model	Year	■	■	■	■	■	ø (mm)	H (mm)
Z1000	10 -	CT028A	CT028B	CT028G	CT028R	CT028U	49	48

KAWASAKI® Z800





Rear set controls "RRC"



Model	Year	
Z800	13 -	PER318B

The installation of the PER318 renders the Z800 a rider only motorcycle with no provision for a passenger. Reverse Gear Change Option: no



Headlight fairing



Model	Year		
Z800 / Z800 ABS	13 -	ZKW026A	ZKW026B



USA VERSION INCLUDED



License plate support

Model	Year	
Z800 / Z800 ABS	13 -	PT313B

Our kit includes: license plate support, license plate support light, indicator light supports, reflector kit.



Engine guard (Carbon)

Model	Year	
Z800	13 -	ZKW018K



Sprocket Cover

Model	Year	
Z800	13 -	ZKW015B

KAWASAKI® Z800





Axle Slider

Model	Year	■	Position
Z800	13 -	PW305A	Front



Engine guards

Model	Year	■
Z800	13 -	PM572A



Brake / Clutch levers "3D"



Model	Year	Type	Reg.	■	■	■
Z800 / Z800 ABS	13 -	Brake	✓	LBJ302A	LBJ302B	LBJ302G
Z800 / Z800 ABS	13 -	Clutch	✓	LCJ302A	LCJ302B	LCJ302G
Z800 / Z800 ABS	13 -	Clutch	—	LCJ301A	LCJ301B	LCJ301G



Brake / Clutch levers "RRC"



Model	Year	Type	Reg.	■	■	■
Z800 / Z800 ABS	13 -	Brake	✓	LBR302A	LBR302B	LBR302G
Z800 / Z800 ABS	13 -	Clutch	✓	LCR301A	LCR301B	LCR301G



Rizoma graphic Kit

Model	Year	■
Z800 / Z800 ABS	13 -	ZKW027B



PROGUARD SYSTEM®

More info on pages 66 - 69

KAWASAKI® Z300

016NEW



USA VERSION
INCLUDED



License plate support



Model	Year	
Z300	15 -	PT316B

Our kit includes: license plate support, license plate support light, indicator light supports, reflector kit.



License plate support "FOX" USA VERSION



Model	Year	
Z300	15 -	PT317B

Our kit includes: license plate support, license plate support light and indicator light supports. The Rizoma License Plate Support PT317B contains only the USA plate holder.



OEM Handlebar caps



Model	Year	■	■	■	■	■
Z300	15 -	MA510A	MA510B	MA510G	MA510R	MA510U



Handlebar cap

Model	Year	■	■
Z300	15 -	MA303A	MA303B



Engine oil filler cap



Model	Year	■	■	■	■	■
Z300	15 -	TP013A	TP013B	TP013G	TP013R	TP013U



PROGUARD SYSTEM®

More info on pages 66 - 69

KAWASAKI® NINJA 1000 ZX-10R





Rear set controls "RRC"

Model	Year	■
NINJA 1000 ZX-10R	11 -	PER317B

Reverse Gear Change Option: included



USA VERSION
INCLUDED



License plate support

Model	Year	■
NINJA 1000 ZX-10R	08 - 09	PT307B
NINJA 1000 ZX-10R	11 -	PT312B

Our kit includes: license plate support, license plate support light, indicator light supports, reflector kit.



Brake / Clutch levers "3D"

Model	Year	Type	Reg.	■	■	■
NINJA 1000 ZX-10R	06 -	Brake	✓	LBJ301A	LBJ301B	LBJ301G
NINJA 1000 ZX-10R	06 -	Clutch	—	LCJ301A	LCJ301B	LCJ301G



Brake / Clutch levers "RRC"

Model	Year	Type	Reg.	■	■	■
NINJA 1000 ZX-10R	06 -	Brake	✓	LBR301A	LBR301B	LBR301G
NINJA 1000 ZX-10R	06 -	Clutch	✓	LCR301A	LCR301B	LCR301G



Engine guards

Model	Year	■
NINJA 1000 ZX-10R	11 -	PM584A



Gas tank cap

Model	Year	■
NINJA 1000 ZX-10R	08 -	TF010A TF010B

KAWASAKI® NINJA 600 / 636 ZX-6R





Rear set controls "RRC"

Model	Year	■
600 ZX-6R / 636 ZX-6R	05 -	PER314B
Reverse Gear Change Option: included		



USA VERSION
INCLUDED



License plate support

Model	Year	■
600 ZX-6R	09 -	PT307B
636 ZX-6R	09 -	PT307B

Our kit includes: license plate support, license plate support light, indicator light supports, reflector kit.



Brake / Clutch levers "3D"

Model	Year	Type	Reg.	■	■	■
600 ZX-6R	07 - 12	Brake	✓	LBJ301A	LBJ301B	LBJ301G
600 ZX-6R	07 -	Clutch	—	LCJ301A	LCJ301B	LCJ301G



Brake / Clutch levers "RRC"

Model	Year	Type	Reg.	■	■	■
600 ZX-6R	07 -	Brake	✓	LBR301A	LBR301B	LBR301G
600 ZX-6R	07 -	Clutch	✓	LCR301A	LCR301B	LCR301G



Engine oil filler cap

Model	Year	■	■	■	■	■
600 ZX-6R	All	TP013A	TP013B	TP013G	TP013R	TP013U



Gas tank cap

Model	Year	■	■
600 ZX-6R	09 -	TF010A	TF010B

KAWASAKI® NINJA 300

016NEW



USA VERSION
INCLUDED



License plate support

Model	Year	
NINJA 300	15 -	PT316B

Our kit includes: license plate support, license plate support light, indicator light supports, reflector kit.



License plate support "FOX" USA VERSION

Model	Year	
NINJA 300	15 -	PT317B

Our kit includes: license plate support, license plate support light and indicator light supports. The Rizoma License Plate Support PT317B contains only the USA plate holder.



OEM Handlebar caps

Model	Year	■	■	■	■	■
NINJA 300	15 -	MA510A	MA510B	MA510G	MA510R	MA510U



Handlebar cap

Model	Year	■	■
NINJA 300	15 -	MA303A	MA303B



Engine oil filler cap

Model	Year	■	■	■	■	■
NINJA 300	15 -	TP013A	TP013B	TP013G	TP013R	TP013U



PROGUARD SYSTEM®

More info on pages 66 - 69

MV AGUSTA® RIVALE





USA VERSION
INCLUDED



License plate support "SIDE ARM"

Model	Year	
RIVALE 800	13 -	PT605B

Our kit includes: license plate support, license plate support light, indicator light supports, reflector kit.



Parafango in Carbon

Model	Year	
RIVALE 800	13 -	ZDM098K

Monta unicamente con License plate support Rizoma PT605.



Riser (with Gauge Bracket)

Model	Year	
RIVALE 800	13 -	AZ701B

1-1/8 inch diameter tapered handlebars on page 94.



Gas tank cap

Model	Year		
RIVALE 800	13 -	TF043A	TF043B



Engine guards

Model	Year	
RIVALE 800	13 -	PM435A



Engine guards

Model	Year	
RIVALE 800	13 -	PM438B

MV AGUSTA® RIVALE





Clutch cover protection - Right

Model	Year	■
RIVALE 800	13 -	PM437B

Attention, the PM438B cYear be used with the PM437B.



Generator cover guard - Left

Model	Year	■
RIVALE 800	13 -	PM436B



Clutch cover protection - Right

Model	Year	■
RIVALE 800	13 -	PM433B



Generator cover guard - Left

Model	Year	■
RIVALE 800	13 -	PM434B



Engine oil filler cap

Model	Year	■	■
RIVALE 800	13 -	TP100B	TP100R



Rizoma Indicator Light adapter for OEM License plate support

Model	Year	■
RIVALE 800	13 -	FR418B

MV AGUSTA® BRUTALE / DRAGSTER 800





Rear set controls "REV"

Model	Year	■
BRUTALE 920	11 -	PE430B
BRUTALE 989 R / 1078 RR / 1090 RR	08 -	PE430B
BRUTALE 910 S	05 - 08	PE430B
BRUTALE 750 S	03 - 05	PE430B

Vertical Adjustment: 10 - 20 mm
 Horizontal Adjustment: 12,5 - 25 mm
 Reverse Gear Change Option: included



USA VERSION INCLUDED



License plate support "SIDE ARM"

Model	Year	■
BRUTALE 800	13 - 15	PT605B
BRUTALE 675	12 -	PT605B

Our kit includes: license plate support, license plate support light, indicator light supports, reflector kit.



Parafango in Carbon

Model	Year	■
BRUTALE 800	13 - 15	ZDM098K
BRUTALE 675	12 -	ZDM098K

Compatible only with Rizoma license plate support PT605.



Rear set controls "RRC"

Model	Year	■
BRUTALE DRAGSTER 800	14 -	PER433B
BRUTALE 800	13 - 15	PER433B
BRUTALE 675	12 -	PER433B

Reverse Gear Change Option: included



USA VERSION INCLUDED



License plate support

Model	Year	■
BRUTALE 800	13 - 15	PT604B
BRUTALE 675	12 -	PT604B
BRUTALE 920	11 -	PT601B
BRUTALE 1090 RR	09 -	PT601B

Our kit includes: license plate support, license plate support light, indicator light supports, reflector kit.



Brake / Clutch levers "RRC"

Model	Year	Type	Reg.	■	■	■
DRAGSTER 800	14 -	Brake	✓	LBR601A	LBR601B	LBR601G
DRAGSTER 800	14 -	Clutch	✓	LCR601A	LCR601B	LCR601G
BRUTALE 800	13 - 15	Brake	✓	LBR601A	LBR601B	LBR601G
BRUTALE 800	13 - 15	Clutch	✓	LCR601A	LCR601B	LCR601G
BRUTALE 675	12 -	Brake	✓	LBR601A	LBR601B	LBR601G
BRUTALE 675	12 -	Clutch	✓	LCR601A	LCR601B	LCR601G

MV AGUSTA® BRUTALE / DRAGSTER 800





Engine / radiator guard

Model	Year	■
BRUTALE DRAGSTER 800	14 -	PM435A
BRUTALE 800	13 -	PM435A
BRUTALE 675	12 -	PM435A



Engine / radiator guard

Model	Year	■
BRUTALE 989 R / 1078 RR	08 -	PM430B
BRUTALE 910 S	05 - 08	PM430B
BRUTALE 750 S	03 - 05	PM430B



Clutch cover protection - Right

Model	Year	■
BRUTALE DRAGSTER 800	14 -	PM437B
BRUTALE 800	13 - 15	PM437B
BRUTALE 675	12 -	PM437B



Generator cover guard - Left

Model	Year	■
BRUTALE DRAGSTER 800	14 -	PM436B
BRUTALE 800	13 - 15	PM436B
BRUTALE 675	12 -	PM436B



Clutch cover protection - Right

Model	Year	■
BRUTALE DRAGSTER 800	14 -	PM433B
BRUTALE 800	13 - 15	PM433B
BRUTALE 675	12 -	PM433B



Generator cover guard - Left

Model	Year	■
BRUTALE DRAGSTER 800	14 -	PM434B
BRUTALE 800	13 - 15	PM434B
BRUTALE 675	12 -	PM434B

MV AGUSTA® F3 675





Rear set controls "RRC"

Model	Year	■
F3 675	12 -	PER433B

Reverse Gear Change Option: included



USA VERSION
INCLUDED



License plate support

Model	Year	■
F3 675	12 -	PT603B

Our kit includes: license plate support, license plate support light, indicator light supports, reflector kit.



Clutch cover protection - Right

Model	Year	■
F3 675	12 -	PM433B



Generator cover guard - Left

Model	Year	■
F3 675	12 -	PM434B



PM437B

PM436B

Clutch cover protection - Right

Model	Year	■	Position
F3 675	13 -	PM437B	Right
F3 675	13 -	PM436B	Left
F3 675	12 -	PM437B	Right
F3 675	12 -	PM436B	Left



Brake / Clutch levers "3D"

Model	Year	Type	Reg.	■	■	■
F3 675	12 -	Brake	✓	LBJ400A	LBJ400B	LBJ400G
F3 675	12 -	Clutch	—	LCJ601A	LCJ601B	LCJ601G

Brake / Clutch levers "RRC"



Model	Year	Type	Reg.	■	■	■
F3 675	12 -	Brake	✓	LBR400A	LBR400B	LBR400G
F3 675	12 -	Clutch	✓	LCR601A	LCR601B	LCR601G

SUZUKI[®] GSR 750 / GSX-S750





USA VERSION
INCLUDED



License plate support

Model	Year	■
GSR 750 / GSX-S750	10 -	PT408B

Our kit includes: license plate support, license plate support light, indicator light supports, reflector kit. Horizontal adjustment.



Engine guards

Model	Year	■
GSR 750 / GSX-S750	10 -	PM167A



Camshaft cover

Model	Year	■
GSR 750 / GSX-S750	10 -	TP031A



Gas tank cap

Model	Year	■	■
GSR 750 / GSX-S750	10 -	TF070A	TF070B



Engine oil filler cap

Model	Year	■	■	■	■	■
GSR 750 / GSX-S750	All	TP009A	TP009B	TP009G	TP009R	TP009U



PROGUARD SYSTEM®

More info on pages 66 - 69



SUZUKI[®] GSX R 1000 / 750 / 600





USA VERSION
INCLUDED



License plate support

Model	Year	■
GSX R 1000	09 -	PT406B

Our kit includes: license plate support, license plate support light, indicator light supports, reflector kit.



USA VERSION
INCLUDED



License plate support

Model	Year	■
GSX R 600 / 750	11 -	PT407B

Our kit includes: license plate support, license plate support light, indicator light supports, reflector kit.



Rear set controls "RRC"

Model	Year	■
GSX R 1000	09 -	PER167B
GSX R 600 / 750	11 -	PER167B

Reverse Gear Change Option: included



Gas tank cap

Model	Year	■	■
GSX R 1000	03 -	TF070A	TF070B
GSX R 600	06 -	TF070A	TF070B
GSX R 750	04 -	TF070A	TF070B



Brake / Clutch levers "3D"

Model	Year	Type	Reg.	■	■	■
GSX R 1000	05 - 06	Brake	✓	LBJ400A	LBJ400B	LBJ400G
GSX R 1000	05 - 06	Clutch	—	LCJ200A	LCJ200B	LCJ200G
GSX R 1000	05 - 06	Clutch	✓	LCJ201A	LCJ201B	LCJ201G
GSX R 600 / 750	06 -	Brake	✓	LBJ400A	LBJ400B	LBJ400G
GSX R 600 / 750	06 -	Clutch	—	LCJ200A	LCJ200B	LCJ200G
GSX R 600 / 750	06 -	Clutch	✓	LCJ201A	LCJ201B	LCJ201G



Brake / Clutch levers "RRC"

Model	Year	Type	Reg.	■	■	■
GSX R 1000	09 -	Brake	✓	LBR400A	LBR400B	LBR400G
GSX R 1000	09 -	Clutch	✓	LCR201A	LCR201B	LCR201G
GSX R 600 / 750	06 -	Brake	✓	LBR400A	LBR400B	LBR400G
GSX R 600 / 750	06 -	Clutch	✓	LCR201A	LCR201B	LCR201G

TRIUMPH® BONNEVILLE T100

016NEW





Brake / Clutch levers "3D"



Model	Year	Type	Reg.	■	■	■
BONNEVILLE T100	14 -	Brake	✓	LBJ100A	LBJ100B	LBJ100G
BONNEVILLE T100	14 -	Clutch	✓	LCJ801A	LCJ801B	LCJ801G



Brake / Clutch levers "RRC"



Model	Year	Type	Reg.	■	■	■
BONNEVILLE T100	14 -	Brake	✓	LBR100A	LBR100B	LBR100G
BONNEVILLE T100	14 -	Clutch	✓	LCR801A	LCR801B	LCR801G



Pegs "STREET"



Model	Year	■
BONNEVILLE T100	14 -	PE642B

To mount pegs adaptors PE766B (Rider) and PE767B (Passenger) are required - (Pair). More info on page 136.



Pegs "TOURING"

Model	Year	■	■	■	■	■
BONNEVILLE T100	14 -	PE622A	PE622B	PE622G	PE622R	PE622U

To mount pegs adaptors PE768B (Rider) and PE769B (Passenger) are required - (Pair). More info on page 137.



USA VERSION INCLUDED



License plate support

Model	Year	■
BONNEVILLE T100	14 -	PT657B

Our kit includes: license plate support, license plate support light and indicator light supports.



Handlebar Cap

Model	Year	■	■
BONNEVILLE T100	08 -	MA303A	MA303B

TRIUMPH® SPEED TRIPLE





Rear set controls



Model	Year	Type	■
1050 / 1050 R	11 - 15	EVO	PE456B
1050	05 - 10	REV	PE450B
955	02 - 04	REV	PE450B

Reverse Gear Change Option: no



Gas tank cap



Model	Year	■	■
1050	08 - 15	TF030A	TF030B



USA VERSION
INCLUDED



License plate support

Model	Year	■
1050 / 1050 R	11 - 15	PT654B

Our kit includes: license plate support, license plate support light, indicator light supports, reflector kit.



USA VERSION
INCLUDED



License plate support "SIDE ARM"

Model	Year	■
1050 / 1050 R	11 - 15	PT655B

Compatible with Rizoma Carbon rear fender ZDM098K.



Crankcase Guard

Model	Year	■	■
1050	05 - 15	ZHH052A	ZHH052B



Axle Slider

Model	Year	■	Position
1050 / 1050 R	11 - 15	PW461A	Front

TRIUMPH® STREET TRIPLE / R / RX





USA VERSION
INCLUDED



License plate support

Model	Year	■
STREET TRIPLE RX	15 -	PT659B

Our kit includes: license plate support, license plate support light, indicator light supports, reflector kit.

PT656B



USA VERSION
INCLUDED



License plate support

Model	Year	■
STREET TRIPLE / R	13 -	PT656B
STREET TRIPLE / R	07 - 12	PT651B

PT651 includes: license plate support, license plate support light, indicator light supports.
PT656 includes: license plate support, license plate support light, indicator light supports, reflector kit.



Engine guards

Model	Year	■
STREET TRIPLE / R	13 -	PM514A
STREET TRIPLE RX	15 -	PM514A



Engine guards

Model	Year	■
STREET TRIPLE / R	07 - 12	PM510B



Engine guards

Model	Year	■
STREET TRIPLE / R	13 -	PM515A
STREET TRIPLE RX	15 -	PM515A



Crankcase guard "CUP EDITION"

Model	Year	■
STREET TRIPLE	07 -	PM511A
STREET TRIPLE R	09 -	PM511A
STREET TRIPLE RX	15 -	PM511A

TRIUMPH® STREET TRIPLE / R / RX





Brake / Clutch levers "3D"

Model	Year	Type	Reg.	■	■	■
STREET TRIPLE	07 -	Brake	✓	LBJ100A	LBJ100B	LBJ100G
STREET TRIPLE R	09 -	Brake	✓	LBJ400A	LBJ400B	LBJ400G
STREET TRIPLE RX	15 -	Brake	✓	LBJ400A	LBJ400B	LBJ400G
STREET TRIPLE	07 -	Clutch	✓	LCJ801A	LCJ801B	LCJ801G
STREET TRIPLE R	09 -	Clutch	✓	LCJ801A	LCJ801B	LCJ801G
STREET TRIPLE RX	15 -	Clutch	✓	LCJ801A	LCJ801B	LCJ801G



Brake / Clutch levers "RRC"

Model	Year	Type	Reg.	■	■	■
STREET TRIPLE	07 -	Brake	✓	LBR100A	LBR100B	LBR100G
STREET TRIPLE R	09 -	Brake	✓	LBR400A	LBR400B	LBR400G
STREET TRIPLE RX	15 -	Brake	✓	LBR400A	LBR400B	LBR400G
STREET TRIPLE	07 -	Clutch	✓	LCR801A	LCR801B	LCR801G
STREET TRIPLE R	09 -	Clutch	✓	LCR801A	LCR801B	LCR801G
STREET TRIPLE RX	15 -	Clutch	✓	LCR801A	LCR801B	LCR801G



Axle Slider

Model	Year	■	Position
STREET TRIPLE / R	09 - 12	PW450A	Front
STREET TRIPLE RX	15 -	PW454A	Front
STREET TRIPLE / R	13 -	PW453A	Rear
STREET TRIPLE RX	15 -	PW453A	Rear



Pegs "B-PRO" for OEM controls

Model	Year	■	■	■	■	■
STREET TRIPLE	07 -	PE630A	PE630B	PE630G	PE630R	PE630U
STREET TRIPLE R	09 -	PE630A	PE630B	PE630G	PE630R	PE630U
STREET TRIPLE RX	15 -	PE630A	PE630B	PE630G	PE630R	PE630U

To mount touring pegs adaptors PE760A (Rider) and PE762A (Passenger) are required. More info on page 131.



Engine oil filler cap

Model	Year	■	■	■	■	■
STREET TRIPLE	09 -	TP008A	TP008B	TP008G	TP008R	TP008U
STREET TRIPLE R	09 -	TP008A	TP008B	TP008G	TP008R	TP008U
STREET TRIPLE RX	15 -	TP008A	TP008B	TP008G	TP008R	TP008U



Gas tank cap

Model	Year	■	■
STREET TRIPLE RX	15 -	TF030A	TF030B
STREET TRIPLE	07 -	TF030A	TF030B
STREET TRIPLE R	09 -	TF030A	TF030B

YAMAHA® XJR 1300



We are pleased to offer you the exclusive Style Line for the XJR1300, designed and produced in official cooperation with Yamaha Motor. The bike specific products are available through Yamaha Europe N.V. Please, contact the Yamaha Motor distributor directly.



To complete the Style Line, please, contact Rizoma directly to order the Universal products, including the PT218B license plate support and all the other products listed in the table below.



USA VERSION
INCLUDED



License plate support

Model	Year	■
XJR 1300	15 -	PT216B

Our kit includes: license plate support, license plate support light, indicator light supports, reflector kit.

The mounting of the PT216B Rizoma Kit, requires to remove the OEM rear light, replaced by the homologated Rear Light included in the Rizoma Kit.



USA VERSION
INCLUDED



License plate support

Model	Year	■
XJR 1300	15 -	PT217B

Our kit includes: license plate support, license plate support light, indicator light supports, reflector kit.

The mounting of the PT217B Rizoma Kit, requires to remove the OEM rear light. In accordance with the highway code, Rizoma recommends use of the "CLUB S" FR155 marker lights, which integrate functions of the stop light, rear light and homologated marker lights.



Engine guards

Model	Year	■
XJR 1300	15 -	PM214A



Brake / Clutch levers "3D"

Model	Year	Type	Reg.	■	■	■
XJR 1300	15 -	Brake	✓	LBJ205A	LBJ205B	LBJ205G
XJR 1300	15 -	Clutch	✓	LCJ802A	LCJ802B	LCJ802G

YAMAHA® XV950R



We are pleased to offer you the exclusive Style Line for the XV950R, designed and produced in official cooperation with Yamaha Motor. The bike specific products are available through Yamaha Europe N.V. Please, contact the Yamaha Motor distributor directly.



To complete the Style Line, please, contact Rizoma directly to order the Universal products, including the PT218B license plate support and all the other products listed in the table below.

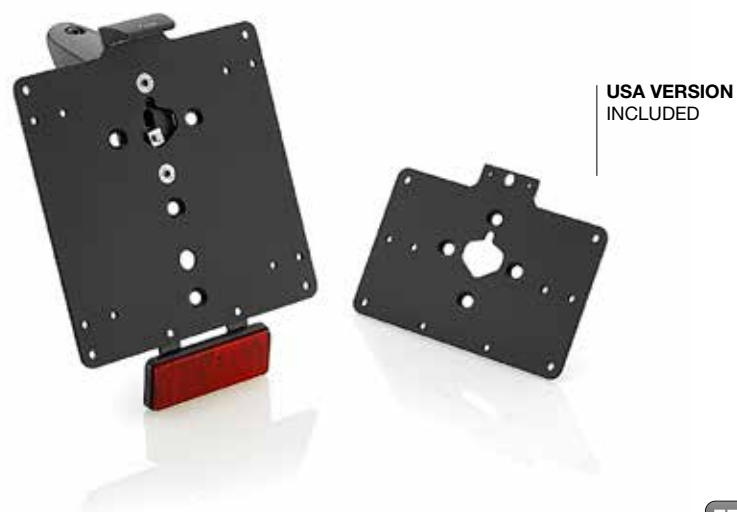

USA VERSION INCLUDED



License plate support

Model	Year	
XV950R	14 -	PT218B

Our kit includes: license plate support, license plate support light, indicator light supports, reflector kit.



Front Marker Light Adaptors (Ø 39/41/43 mm)

FR228B

YAMAHA® MT-09 TRACER / FJ-09

016NEW





Passenger Peg mount Kit

Model	Year	■
MT-09 TRACER / FJ-09	15 -	PE680B

The RIZOMA PE680B Passenger Peg Mounts ensure optimal comfort:

- 40 mm rearward compared to the OEM location
- Adjustable in height, resulting from 30 to 50 mm lower than the OEM location, making it more comfortable for the passenger.
- They are compatible with both OEM and RIZOMA Footpegs (PE676A adapter required, see p. 132-133).

The quality fit, finish and durability of RIZOMA.
 Attention: the PE680B cannot be installed with Yamaha OEM saddlebags.
 Passenger pegs not included.



USA VERSION
INCLUDED



License plate support

Model	Year	■
MT-09 TRACER / FJ-09	15 -	PT214B

Front Brake Fluid Tank Cap

Model	Year	■
MT-09 TRACER / FJ-09	15 -	TP036B



Engine guards

Model	Year	■
MT-09 TRACER / FJ-09	15 -	PM212A



Axle Slider

Model	Year	■	Position
MT-09 TRACER / FJ-09	15 -	PW103A	Front

YAMAHA® MT-09 / FZ-09





USA VERSION
INCLUDED



License plate support

Model	Year	
MT-09 / FZ-09	13 -	PT214B

Our kit includes: license plate support, license plate support light, indicator light supports, reflector kit. PT214B mounts Rizoma Tail Light ZYF017B and also OEM Tail Light.



Tail Light

Model	Year	
MT-09 / FZ-09	13 -	ZYF017B

ZYF017B mounts on Rizoma License plate Support PT214B and also on OEM License plate Support.



ZYF019A



Headlight fairing

Model	Year	Type		
MT-09 / FZ-09	13 -	Aluminium	ZYF019A	ZYF019B
MT-09 / FZ-09	13 -	Polycarbonate	—	ZYF020B



Rizoma graphic Kit

Model	Year	
MT-09 / FZ-09	13 -	ZYF018B



Brake / Clutch levers "3D"

Model	Year	Type	Reg.			
MT-09 / FZ-09	13 -	Brake	✓	LBJ205A	LBJ205B	LBJ205G
MT-09 / FZ-09	13 -	Clutch	—	LCJ200A	LCJ200B	LCJ200G
MT-09 / FZ-09	13 -	Clutch	✓	LCJ201A	LCJ201B	LCJ201G



Brake / Clutch levers "RRC"

Model	Year	Type	Reg.			
MT-09 / FZ-09	13 -	Brake	✓	LBR205A	LBR205B	LBR205G
MT-09 / FZ-09	13 -	Clutch	✓	LCR201A	LCR201B	LCR201G

YAMAHA® MT-09 / FZ-09





Passenger Peg mount Kit

Model	Year	■
MT-09 / FZ-09	13 -	PE680B

The RIZOMA PE680B Passenger Peg Mounts ensure optimal comfort:

- 40 mm rearward compared to the OEM location
- Adjustable in height, resulting from 30 to 50 mm lower than the OEM location, making it more comfortable for the passenger.
- They are compatible with both OEM and RIZOMA Footpegs (PE676A adapter required, see p. 132-133).

The quality fit, finish and durability of RIZOMA.

Warning: the PE680B cannot be installed with Yamaha OEM saddlebags. Passenger pegs not included.



Engine guards

Model	Year	■
MT-09 / FZ-09	13 -	PM212A



Axle Slider

Model	Year	■	Position
MT-09 / FZ-09	13 -	PW103A	Front



Front Brake Fluid Tank Cap

Model	Year	■
MT-09 / FZ-09	13 -	TP036B



Gas tank cap

Model	Year	■	■
MT-09 / FZ-09	13 -	TF061A	TF061B



YAMAHA® MT-07 / FZ-07



ZYF019A



Headlight fairing

Model	Year	Type	■	■
MT-07 / FZ-07	14 -	Aluminium	ZYF019A	ZYF019B
MT-07 / FZ-07	14 -	Polycarbonate	—	ZYF020B

Front Brake Fluid Tank Cap

Model	Year	■
MT-07 / FZ-07	14 -	TP036B



Brake / Clutch levers "3D"

Model	Year	Type	Reg.	■	■	■
MT-07 / FZ-07	14 -	Brake	✓	LBJ205A	LBJ205B	LBJ205G
MT-07 / FZ-07	14 -	Clutch	—	LCJ200A	LCJ200B	LCJ200G
MT-07 / FZ-07	14 -	Clutch	✓	LCJ201A	LCJ201B	LCJ201G



USA VERSION
INCLUDED



Brake / Clutch levers "RRC"

Model	Year	Type	Reg.	■	■	■
MT-07 / FZ-07	14 -	Brake	✓	LBR205A	LBR205B	LBR205G
MT-07 / FZ-07	14 -	Clutch	✓	LCR201A	LCR201B	LCR201G

License plate support

Model	Year	■
MT-07 / FZ-07	14 -	PT215B

Our kit includes: license plate support, license plate support light, OEM indicator light supports, reflector kit.



Engine guards

Model	Year	■
MT-07 / FZ-07	14 -	PM213A



Axle Slider

Model	Year	■	Position
MT-07 / FZ-07	14 -	PW104A	Front

YAMAHA® YZF-R1

016UPDATE





Rear set controls

Model	Year	Type	■
YZF-R1	15 -	SPORT R	PER128B
YZF-R1	09 - 14	RRC	PER124B

Reverse Gear Change Option: included



Brake / Clutch levers "3D"

Model	Year	Type	Reg.	■	■	■
YZF-R1	15 -	Brake	✓	LBJ210A ¹	LBJ210B ¹	LBJ210G ¹
YZF-R1	15 -	Clutch	✓	LCJ210A	LCJ210B	LCJ210G
YZF-R1	07 - 08	Brake	✓	LBJ201A	LBJ201B	LBJ201G
YZF-R1	07 - 08	Clutch	—	LCJ200A	LCJ200B	LCJ200G
YZF-R1	07 - 08	Clutch	✓	LCJ201A	LCJ201B	LCJ201G

¹ LBJ210: is compatible with the Rizoma RM004 Remote Adjuster sold separately in three colors.



Brake / Clutch levers "RRC"

Model	Year	Type	Reg.	■	■	■
YZF-R1	15 -	Brake	✓	LBR210A	LBR210B	LBR210G
YZF-R1	15 -	Clutch	✓	LCR201A	LCR201B	LCR201G
YZF-R1	09 - 14	Brake	✓	LBR206A	LBR206B	LBR206G
YZF-R1	09 - 14	Clutch	✓	LCR201A	LCR201B	LCR201G



USA VERSION INCLUDED



License plate support

Model	Year	■
YZF-R1	15 -	PT219B
YZF-R1	09 - 14	PT210B
YZF-R1	04 - 08	PT207B

Our kit includes: license plate support, license plate support light, indicator light supports, reflector kit.



Remote Adjuster

Model	Year	■	■	■
YZF-R1	15 -	RM004B	RM004R	RM004RU

RM004 is compatible only in combination with the Rizoma Break Lever LBJ210.



PM552A



PM553A

Engine guards

Model	Year	■	Position
YZF-R1	09 - 14	PM552A	Right
YZF-R1	09 - 14	PM553A	Left

YAMAHA® YZF-R1





Fairing guards

Model	Year	■
YZF-R1	15 -	PM215B



Clutch cover protection

Model	Year	■	■	■
YZF-R1	15 -	PM218B	PM218R	PM218U



Engine cover protection - Right

Model	Year	■	■	■
YZF-R1	15 -	PM217B	PM217R	PM217U



Engine cover protection - Left

Model	Year	■	■	■
YZF-R1	15 -	PM216B	PM216R	PM216U



Axle Slider

Model	Year	■	Position
YZF-R1	15 -	PWR105B	Front
YZF-R1	15 -	PWR106B	Rear

Rizoma "SPORT R" wheel axle guards have been created for supersport bikes and their use on the track. In addition to protecting the wheel axle, they have been designed to speed up removal and installation of the wheel pin, to simplify the replacement of the front or rear wheel.

YAMAHA® YZF R6





Rear set controls "RRC"

Model	Year	■
YZF R6	06 -	PER123B

Reverse Gear Change Option: included



USA VERSION
INCLUDED



License plate support

Model	Year	■
YZF R6	06 -	PT204B

Our kit includes: license plate support, license plate support light, indicator light supports, reflector kit.



Fairing guards

Model	Year	■
YZF R6	08 -	PM210B



Gas tank cap

Model	Year	■
YZF R6	03 -	TF061A TF061B



Brake / Clutch levers "3D"

Model	Year	Type	Reg.	■	■	■
YZF R6	06 -	Brake	✓	LBJ201A	LBJ201B	LBJ201G
YZF R6	06 -	Clutch	—	LCJ200A	LCJ200B	LCJ200G
YZF R6	06 -	Clutch	✓	LCJ201A	LCJ201B	LCJ201G



Brake / Clutch levers "RRC"

Model	Year	Type	Reg.	■	■	■
YZF R6	06 -	Brake	✓	LBR201A	LBR201B	LBR201G
YZF R6	06 -	Clutch	✓	LCR201A	LCR201B	LCR201G

YAMAHA® T-MAX





Riser Kit

Model	Year	■
T-MAX 500	08 - 11	MA400B
T-MAX 530 / 530 ABS	12 -	MA400B

Tapered handlebars are compatible only with RIZOMA riser kit MA400B. MA006B tapered handlebar not included.

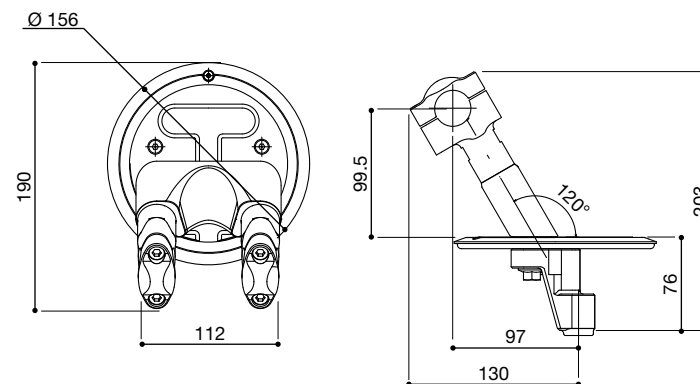

Parking brake lever

Model	Year	■	■	■
T-MAX 500	08 - 11	ZYF005A	ZYF005B	ZYF005G
T-MAX 530 / 530 ABS	12 -	ZYF005A	ZYF005B	ZYF005G



Brake fluid tank cap

Model	Year	■	■	■	■
T-MAX 500	04 - 11	ZYF006A	ZYF006B	ZYF006G	ZYF006R
T-MAX 530 / 530 ABS	12 -	ZYF006A	ZYF006B	ZYF006G	ZYF006R



Sump Cover

Model	Year	■
T-MAX 530 / 530 ABS	12 -	ZYF013A



Pulley Cover

Model	Year	■
T-MAX 530 / 530 ABS	12 - 14	ZYF014A



USA VERSION
INCLUDED



License plate support

Model	Year	■
T-MAX 530 / 530 ABS	12 -	PT213B



USA VERSION
INCLUDED



License plate support

Model	Year	■
T-MAX 500	08 - 11	PT209B

Our kit includes: license plate support, license plate support light, indicator light supports, reflector kit.



Cover Carter

Model	Year	■
T-MAX 500	04 -	ZYF009B
T-MAX 530 / 530 ABS	12 -	ZYF009B



Axle Slider

Model	Year	■	Position
T-MAX 500	08 - 11	PW102A	Front
T-MAX 530 / 530 ABS	12 - 14	PW102A	Front



Leva Brake Front / Rear "3D"

Model	Year	Type	Reg.	■	■	■
T-MAX 500	08 - 11	Brake Front	✓	LBJ205A	LBJ205B	LBJ205G
T-MAX 500	08 - 11	Brake Rear	✓	LBJ202A	LBJ202B	LBJ202G
TMAX530/530ABS	12 -	Brake Front	✓	LBJ205A	LBJ205B	LBJ205G
TMAX530/530ABS	12 -	Brake Rear	✓	LBJ202A	LBJ202B	LBJ202G



Footrest rear side

Model	Year	■
T-MAX 530 / 530 ABS	12 -	ZYF012A



Footrest front side

Model	Year	■
T-MAX 530 / 530 ABS	12 -	ZYF011A



Silencer Jet

Model	Year	■
T-MAX 500	08 - 11	ZYF015B
T-MAX 530 / 530 ABS	12 -	ZYF015B



BS806A



BS522B

Mirror hole cap

Model	Year	■	■
T-MAX 500	08 - 11	—	BS522B
T-MAX 530 / 530 ABS	12 -	BS806A	—

BS806: Anticorodal® 100



Handlebar Mirror adapter

Model	Year	■
T-MAX 500	08 - 11	BS775B
T-MAX 530 / 530 ABS	12 -	BS775B

BS775: Anticorodal®



BS786B



BS805B

Fairing Mirror adapter

Model	Year	■
T-MAX 500	08 - 11	BS786B

Fairing Mirror adapter

Model	Year	■
T-MAX 530 / 530 ABS	12 -	BS805B

BS786: PVC + Anticorodal®
BS805: Anticorodal® + ABS

Symbol keys



Products which have a TÜV-Approval included.



Products which have aN ABE-Approval included.



The RIZOMA Support Plates are tested in accordance with the European Regulations 93/94/EEC.



Products which have a "E-Homologation" included.



Accessories with design registration.



Mirrors equipped with High-Quality "Blue Style" Mirror-Glasses, "amber" Mirror-Glass or convex mirror glass.



Integrated marker light mirror.



The aspheric mirror glass is curved outward slightly to widen the field of vision.

Certification & Homologation

The certification and homologation granted to a large number of our accessories constitute an essential phase of the production process: a certificate of conformity is a statement that assures the high level functionality and performance of a product. An additional aesthetic type of approval certifies the unique and original design of our products and distinguishes even more our brand-name.

Legal notes

The trademarks APRILIA®, BUELL®, BMW®, DUCATI®, HARLEY-DAVIDSON®, HONDA®, KAWASAKI®, KTM®, MOTO MORINI®, MV AGUSTA®, SUZUKI®, TRIUMPH®, YAMAHA® belongs to its proprietor. Rizoma and APRILIA®, BUELL®, BMW®, DUCATI®, HARLEY-DAVIDSON®, HONDA®, KAWASAKI®, KTM®, MOTO MORINI®, MV AGUSTA®, SUZUKI®, TRIUMPH®, YAMAHA® are distinguished entities between which there is not any kind of connection.

The products we produce are guaranteed for quality, strength and durability. Notwithstanding that, not all of our products are approved for a road traffic use in those Countries where, instead, it is required the approval and, therefore, Rizoma cannot be deemed liable for the damages suffered by the user as a result of a use that does not comply with the safety regulations of the Countries in which the products are sold.

RIZOMA® S.r.l. declines to accept any liability that derives from a non-compliant use of its products. Rizoma® S.r.l. exhort the dealers to inform the buyers of such disclaimer. Rizoma and its collaborators cannot be deemed liable under any circumstances for any negligence or direct, indirect, incidental or consequent damage connected to the use of the products of this catalogue, also included, without any limitation, damages as loss of profits or turnover, business or professional interruption etc. This clause is not intended to avoid the requirements prescribed by law, nor exclude the liability for those cases in which it cannot be excluded pursuant to the applicable regulations.

The contents of the catalogue, by way of examples and not exhaustive, works, images, photographs, dialogs, texts and any kind of any material in any format, included, by way of examples and not exhaustive, the graphic, the colors, the schemes, the tools, the characters, the design, the diagrams, the layouts, the methods, the processes, (individually and / or collectively, defined as "Content") and the related distinctive feature and / or logos are the exclusive property of Rizoma, except what is identified as belonging to third parties / producers, or anyhow in its exclusive availability, and in any case cannot be in any manner and/or form used without the prior written consent of Rizoma. Unless otherwise expressly specified on the catalogue, the Content can be viewed without the right and / or possibility of temporary or permanent reproduction, distribution, redistribution, disclosure or other use, in any form or manner that does not respect Rizoma's copyrights with regard to industrial and intellectual property.

Any reproduction, duplication, distribution of the contents of this catalogue and any other use not expressly authorized is a criminal and civil offense, punishable by law.

All products with trademarks, names or acronyms of identification of motorcycles are intended exclusively as a reference for the use of our accessories.

The delivery and / or possession of this catalogue does not give any right to use any of the catalogue's content. The sales price indicated in euros shall be calculated as "Italian Ex Works" and they are inclusive of the VAT (Value Added Tax). The prices of this catalogue are not binding.

Warning: Rizoma products are developed and tested on motorcycles. Therefore, the company cannot be deemed liable in case of problems related to the installation of our products on not OEM parts.

The user acknowledges and agrees: (i) that Rizoma has the right to change the terms and conditions of this legal notes at any time by communicating the occurred changes to users through a general notice published on the Website or through a link to that notice and (ii) that from the notice of any change, the changed legal notes will be the new terms and conditions that will regulate the use of the material in the catalogue (this legal notes, even with further amendments, are defined "Legal Notes".)

This legal notes are regulated by Italian Law.

**HEADQUARTERS**

RIZOMA Srl
Via Quarto, 32
21010 Ferno (VA) ITALY
tel. +39 0331 242020
fax +39 0331 242021
info@rizoma.com

rizoma.com

UNITED STATES

RIZOMA USA Inc.
9230 West Olympic Blvd, Ste 100
Beverly Hills, CA 90212
310-2-RIZOMA (310.274.9662)
877-RIZOMA-1 (877.749.6621)
usa@rizoma.com

SWITZERLAND

tel. +41 (32) 6770514
switzerland@rizoma.com

LATIN-AMERICA OFFICE

tel. +34 936 671 359
tel. +34 607 025 070
fax +39 0331 242021
latin-america@rizoma.com

SCANDINAVIA

tel. +45 (47) 528384
scandinavia@rizoma.com

GERMANY OFFICE

Hermann-Hagenmeyer-Str. 4
71636 Ludwigsburg
tel. +49 (0)7141 972 29-0
fax +49 (0)7141 972 29-18
germany@rizoma.de

FRANCE OFFICE

tel. +33 (0)1 49613067
fax +33 (0)1 49618977
france@rizoma.com

SPAIN OFFICE

Barcelona
Toll free nr. 900 966 937
tel. +34 936 671 359
fax +39 0331 242021
spain@rizoma.com

AUSTRIA

tel. +43 (650) 3333051
austria@rizoma.com